

# Dentistry Catalog

No. 17



**HÄGER  
WERKEN**

Dentalprodukte weltweit  
Dental Products Worldwide

## Our team worldwide



See our Xylitol range on page 71.



Patrick Hager,  
General Manager

Michael Hager,  
Senior Adviser



Hager Worldwide, Inc.  
441-A 19<sup>th</sup> Street S.E.  
Hickory N.C. 28602, USA  
Tel.: (800) 328-2335, Tel.: (001) 828 624 3300  
Fax: (800) 573-9392, Fax: (813) 926-7473  
E-Mail: [contact@hagerworldwide.com](mailto:contact@hagerworldwide.com)  
Website: [www.hagerworldwide.com](http://www.hagerworldwide.com)  
General Manager: Mark Schneider



Hager Polonia Sp. z o.o.  
Ul. Galszynskiego 23  
52-214 Wrocław  
Telefon 1: +48 - 71-368-71-66  
Telefon 2: +48 - 71-368-71-37  
Fax: +48 - 71-368-10-21  
E-Mail: [biuro@hager.com.pl](mailto:biuro@hager.com.pl)  
General Manager: Ania Biernacka-Swienc



"HAGER EURASIA" OOO  
127051, Moscow, Russia  
Tsvetnoy bulvard, 30, Bldg. 1  
Mobil GER: +49 (177) 69 22 680  
Mobil RUS: +7 (985) 99 39 401  
E-Mail: [o.seifert@hagerwerken.de](mailto:o.seifert@hagerwerken.de)  
General Manager: Olga Seifert



HAGER PHARMA GmbH  
Ackerstraße 1, 47269 Duisburg  
Tel. +49 (203) 99 269 900, Fax +49 (203) 99 269 999  
[info@hager-pharma.de](mailto:info@hager-pharma.de), [www.hager-pharma.de](http://www.hager-pharma.de)  
General Manager: Klemens Böhm



Mob(HK): +852-9168 0419  
Mob: +86-138 1780 6110  
Tel(HK): +852-2622 2796  
Tel: +86-21-6210 3519  
E-Mail: [kate@hagerasia.com.hk](mailto:kate@hagerasia.com.hk)  
General Manager: Kate Tsui

Shanghai Office  
Unit 1, 20th Floor,  
Zhao Feng Trading Building,  
369 Jiangsu Road  
Shanghai 20050, China  
Tel: +86-21-5239 8136  
Fax: +86-21-5239 8135  
E-Mail: [info@hagerasia.com](mailto:info@hagerasia.com)

Hong Kong Office  
Unit 5 & 10, 9/F,  
139-141 Hoi Bun Road, Seaview Centre  
Kowloon, Hong Kong  
Tel: +852-2622 2795  
Fax: +852-2622 2503  
E-Mail: [info@hagerasia.com.hk](mailto:info@hagerasia.com.hk)



Hager & Werken GmbH & Co. KG  
Ackerstraße 1, 47269 Duisburg,  
Germany  
Telefon +49 (203) 99269-0  
Fax +49 (203) 299283  
E-Mail [info@hagerwerken.de](mailto:info@hagerwerken.de)  
Internet [www.hagerwerken.de](http://www.hagerwerken.de)  
General Manager: Patrick Hager

## Hager & Werken – The Catalog

This 17th edition of our English catalog offers a variety of new, innovative products. Over the years, the Hager & Werken catalog has become a compendium for interesting dental specialties, consumables and innovative small equipment. We dedicate ourselves to provide the dental community with the highest level of quality products and services.

One of the most important new products is LaserHF "comfort" – a combination of Laser- and Radiosurgery in one device, offering the advantages of both worlds. This unique combination is not only space-saving and effective, but also very attractive price wise.

With ImplantMarker Hager & Werken offers a unique preventive care system for dental implants. Within minutes hidden inflammations can be diagnosed reliably in a very early stage long before conventional methods would show anything. The dentist can start his treatment and take counter measurements right away.

A strict quality control system is the basis for our sustained success and growth. Hager & Werken has established a rigid quality management system according to ISO 9001 and ISO 13485 (certified by TÜV Rheinland, Cologne – Germany). This assures that our products are manufactured and distributed under highest possible standards

## Our team – always at your service!

For questions and orders please contact our sales representatives, our sales team in Duisburg or your dental dealer. Detailed and up-to-date information about our products can be found on the Internet at:

[www.hagerwerken.de](http://www.hagerwerken.de) and [www.miradent.de](http://www.miradent.de)

## Our team in Duisburg is available

**Monday to Thursday 08.00 – 17.00  
and Friday 08.00 – 16.00**

**Fon: +49 (203) 99 269 + extension number**

**Fax: +49(203) 29 92 83**

### Service Export

Susanne Bah, [s.bah@hagerwerken.de](mailto:s.bah@hagerwerken.de)

- 45

Anneli Heyse, [a.heyse@hagerwerken.de](mailto:a.heyse@hagerwerken.de)

- 43

Lidia Benedetti, [l.benedetti@hagerwerken.de](mailto:l.benedetti@hagerwerken.de)

- 42

Julia Heckmann, [j.heckmann@hagerwerken.de](mailto:j.heckmann@hagerwerken.de)

- 47

### Technical Service

Kuno Kunert, [k.kunert@hagerwerken.de](mailto:k.kunert@hagerwerken.de)

### European Sales and Marketing Director

Marcus van Dijk, [m.vandijk@hagerwerken.de](mailto:m.vandijk@hagerwerken.de)

- 16

### European Sales Manager

Jörg Zensen, [j.zensen@hagerwerken.de](mailto:j.zensen@hagerwerken.de)

+49 (172) 210 72 03

### Sales Manager Austria/Switzerland

Simone Krug, [s.krug@hagerwerken.de](mailto:s.krug@hagerwerken.de)

+43 (664) 150 1417

### Sales Manager France/Spain/Portugal

Séverine Sánchez, [s.sanchez@hagerwerken.de](mailto:s.sanchez@hagerwerken.de)

+34 (687) 381 020

### Sales Manager Adriatic Region

Klaudija Mateljak, [Klaudija@hagerwerken.de](mailto:Klaudija@hagerwerken.de)

+385 (98) 997 4678

### Junior Sales Manager Africa

Pedro Nkanu, [p.nkanu@hagerwerken.de](mailto:p.nkanu@hagerwerken.de)

- 631

# Always at your service



German headquarters



Exportteam and technical service



Hager Worldwide Corporate Office Hickory, North Carolina

# Index Products

|                               |           |                               |              |                                  |              |                                   |           |
|-------------------------------|-----------|-------------------------------|--------------|----------------------------------|--------------|-----------------------------------|-----------|
| Airsonic Absorbo Box          | 48        | <b>Hager Outback's</b>        | <b>29</b>    | Miraject                         | 15           | Reflect-Rhod                      | 25        |
| Airsonic Adapter              | 48        | <b>halitosis spray</b>        | <b>79</b>    | Miraject Endo Luer               | 16           | Reso-Pac                          | 51        |
| Airsonic Alu-Oxyd             | 48        | Happy Morning                 | 72           | Miraject Endo Rinse              | 17           | Röntgomarker                      | 53        |
| Airsonic Mini Sandblaster     | 48        | Happy Morning De Luxe         | 72           | Miraject Endotec Duo             | 17           | Rotoprox                          | 59        |
| Algilock                      | 10        | Happy Morning Travel Kit      | 72           | Miraject Endotec Luer            | 17           |                                   |           |
| Algilock Cleaner Plus         | 10        | Happy Morning® Xylitol        | 83           | Miraject Luer                    | 15           | <b>Skalpelli-Ex / Pin-Clipper</b> | <b>23</b> |
| Algilock Perforated           | 10        | <b>hf1 Surg bipolar</b>       | <b>55</b>    | Miraject PL Super                | 16           | Spandex                           | 24        |
| Algimix                       | 12        | <b>hf Bipolar-Forceps</b>     | <b>56</b>    | Miraject P / P Super             | 16           | Spandex-Vertical                  | 24        |
| Alpha-Ion Toothbrushes        | 72        | hf Electrodes                 | 56           | Miralay                          | 23           | Speed Labolight                   | 60        |
| Amalgam Well                  | 45        | hf Neutral Electrode          | 56           | Miramask                         | 27           | Speedo-Clean                      | 61        |
| Anti Stress Tooth             | 87        | H&W Classic                   | 28           | Miramatic                        | 18           | Steri-Suc-Tube                    | 34        |
| Apply Tips                    | 20        |                               |              | Miramatic Aspi                   | 19           | Study Models                      | 68-69     |
| APT Gas                       | 62        | <b>ImplantMarker</b>          | <b>83</b>    | Miramatic-Box                    | 18           | Super-Splint                      | 42        |
| APT III Burner                | 62        | Infant-O-Brush                | 80           | Miramatic Holder Plus            | 19           | Super-Splint De Luxe              | 42        |
| Armatron Pro                  | 62        | Integra Fit-On Tray           | 64           | Miramatic Syringes               | 19           |                                   |           |
| Astro Clean                   | 27        | Integra Cart                  | 64           | Mira-Post                        | 47           | <b>Tong-Clin De Luxe</b>          | <b>82</b> |
|                               |           | I-Prox Care Set               | 77           | <b>mirasensitive hap*</b>        | <b>70</b>    | Tong-Clin Gel                     | 82        |
| <b>BD-Steribox</b>            | <b>21</b> | I-Prox chx                    | 75           | Mirasuc 16                       | 32           | Toothbrushing Model               | 68        |
| Blue-Flame 1500               | 63        | I-Prox P                      | 77           | Mirasuc Adapter                  | 32           | Tweezer PL                        | 22        |
| Bravo Portable II             | 58        |                               |              | Mirasuc Brush                    | 34           | Twin-Pipette                      | 21        |
| Bravo TD III                  | 60        | <b>Kid's Brush</b>            | <b>81</b>    | Mirasucto                        | 33           |                                   |           |
| Brillant                      | 25        | Kisag Burner                  | 63           | Mirasuc-View                     | 32           | <b>Uvex Astro Lite</b>            | <b>29</b> |
| Brillant Anti-Fog             | 25        |                               |              | <b>Miratoi toys</b>              | <b>84-86</b> | uvex Astrospec                    | 29        |
|                               |           | <b>LaserHF Bleaching</b>      |              | Mirator 2000                     | 12           | <b>uvex i-3</b>                   | <b>30</b> |
| <b>Calci-Line</b>             | <b>43</b> | <b>Hand Piece</b>             | <b>57</b>    | Miratorch                        | 63           | <b>uvex Pheos</b>                 | <b>30</b> |
| CC-Shield                     | 30        | <b>LaserHF "comfort"</b>      | <b>54-55</b> | Miratrach                        | 8-9          | uvex Super-Fit                    | 28        |
| Cervical clamp 214            | 36        | <b>LaserHF Curver</b>         | <b>57</b>    | Miratrach 140°                   | 9            | uvex Super-Fit UV                 | 28        |
| C-EX / B-EX                   | 44        | <b>LaserHF Fibre Cutter</b>   | <b>57</b>    | Miratrach Implant                | 8            | uvex Super G                      | 28        |
| Chiru-Cleaner                 | 34        | <b>LaserHF Fibre-Tips</b>     | <b>57</b>    | Miratrach Mini                   | 9            | uvex Ultra-Spec                   | 29        |
| Chirurgo-Suc I                | 34        | <b>LaserHF PDT Solution</b>   | <b>56</b>    | Miratrach Partial                | 9            |                                   |           |
| Chiru-Tip                     | 34        | laservision Lambda One        | 31           | Miratrach Spray                  | 9            | <b>Variator-Kit</b>               | <b>22</b> |
| Cold-Bag                      | 26        | laservision Patient's Glasses | 31           | Mirawhite gelée                  | 73           | <b>X-Ray Mesh</b>                 | <b>53</b> |
| <b>Comfort Dreams</b>         | <b>87</b> | laservision Skyline Blue      | 31           | <b>Mirawhite Laser Bleaching</b> | <b>57</b>    | X-Ray Stain Remover               | 53        |
| Contact Gauge                 | 45        | laservision Skyline Green     | 31           | Mirawhite oxygen                 | 70           | Xylitol Chewing Gum               | 71        |
| Cotton-Clip                   | 23        | Liftbox                       | 22           | Myzotect-Tincture                | 51           | <b>Xylitol Drops</b>              | <b>71</b> |
| Cottoroll                     | 23        | Luer                          | 14           |                                  |              | Xylitol Powder                    | 71        |
| Crown Click De Luxe           | 44        | <b>Matrix-Retainers</b>       | <b>43</b>    | <b>Napkin Holder Big</b>         | <b>21</b>    |                                   |           |
| Cyano Ex                      | 41        | Mc Tooth Mirror               | 68           | N2 Endodontic Cement             | 49           | <b>Zahnpick</b>                   | <b>75</b> |
| Cyano-Veneer                  | 41        | Membranbox                    | 13           |                                  |              |                                   |           |
| Cyano-Veneer Powder           | 41        | Micro-Etch                    | 43           | <b>Occlu-Print</b>               | <b>43</b>    |                                   |           |
| Cyano-Veneer Supplies         | 41        | Mira-2-Ton Liquid             | 78           | Occlu Spray Plus                 | 45           |                                   |           |
|                               |           | Mira-2-Ton Tablets            | 78           | Orange Solvent                   | 26           |                                   |           |
| <b>Dapp-a-Way</b>             | <b>66</b> | Mirabol                       | 12           | Orbatec                          | 58           |                                   |           |
| Dento Box I                   | 80        | Mirabrush                     | 20           | Orbatec Prophy                   | 58           |                                   |           |
| Dento Box I + II              | 13        | Mira Clean                    | 66           |                                  |              |                                   |           |
| Desmoclean                    | 49        | Miraclean-Implant Black       | 50           | <b>Panascope</b>                 | <b>53</b>    |                                   |           |
|                               |           | <b>Mira Cleaning Wipes</b>    | <b>27</b>    | Parallelometer-Mirror            | 25           |                                   |           |
| <b>Emmenix Film Holder</b>    | <b>52</b> | Mira-Clin P                   | 66           | paroguard chx                    | 79           |                                   |           |
| Emmenix Flap                  | 52        | Miraclip                      | 21           | Pelotte-Aspirator                | 33           |                                   |           |
| Endotec Luer                  | 14        | Miracold Plus                 | 26           | Pelotte Plus                     | 33           |                                   |           |
| Endotec Luer Duo              | 14        | miradent Demo Box             | 77           | Perfect Splint C                 | 42           |                                   |           |
| Exact Liner                   | 45        | miradent Hourglass            | 80           | Perfect Splint-System            | 42           |                                   |           |
|                               |           | miradent SOS Dentobox         | 78           | <b>PerioMarker</b>               | <b>83</b>    |                                   |           |
| <b>Fit Plast Frame</b>        | <b>40</b> | Miradont-Gel                  | 51           | Pic-Brush Refill Brushes         | 76           |                                   |           |
| Fit Rubberdam Eliot Separator | 40        | Mira-Duo                      | 68           | Pic-Brush Intro Kit              | 76           |                                   |           |
| Fit Rubberdam Clamps for      |           | Mirafit 3 in 1                | 46           | Pic-Brush Set                    | 76           |                                   |           |
| Children                      | 37        | Mirafit BC                    | 45           | Pick up Stick                    | 20           |                                   |           |
| Fit Rubberdam Clamp board     | 35        | Mirafit Carbon and White      | 46           | <b>Plantana</b>                  | <b>87</b>    |                                   |           |
| Fit Rubberdam Clamps          | 36-39     | <b>Mirafit Clear</b>          | <b>47</b>    | Plaque Agent                     | 81           |                                   |           |
| Fit Rubberdam Forceps         | 35        | Mirafloss                     | 74           | Praxipolish Plus                 | 27           |                                   |           |
| Fit Rubberdam-Latex           | 40        | Mirafloss Big                 | 74           | Prepometer                       | 65           |                                   |           |
| Fit Rubberdam Starter Kit I   | 35        | Mirafloss Implant chx         | 74           | Prophy-Angles                    | 59           |                                   |           |
| Fit Rubberdam Starter Kit II  | 35        | Mirafloss Interspace          | 74           | Prophy-Cups                      | 59           |                                   |           |
| Fit Rubberdam Steel Frame     | 40        | mirafleur c                   | 73           | Prophy-Mandrell                  | 59           |                                   |           |
| Fit Rubberdam Template        | 35        | mirafleur chx                 | 79           | Prophy-Ring                      | 66           |                                   |           |
| Flexbrush                     | 26        | mirafleur-gel                 | 67 / 73      | Protectoray                      | 52           |                                   |           |
| Flex-O-Bol                    | 12        | Mirafleurid                   | 67           | Protho Box                       | 82           |                                   |           |
| Funny Animals                 | 81        | mirafleur-k-gel (for Kids)    | 67 / 73      | Protho Brush De Luxe             | 82           |                                   |           |
|                               |           | Mirafleur -Tray               | 67           | Protho Clean                     | 61           |                                   |           |
| <b>GapSeal</b>                | <b>11</b> | Miraglu                       | 50           | Proto-Cam                        | 30           |                                   |           |
| Glass Bead Heater             | 61        | Mirahold                      | 24           | Putzi-Animals                    | 84           |                                   |           |
| Gripit                        | 44        | Mirahold -Block               | 24           |                                  |              |                                   |           |
|                               |           | Miraimplant                   | 50           |                                  |              |                                   |           |

|                                      |       |                                       |       |                                       |       |  |       |
|--------------------------------------|-------|---------------------------------------|-------|---------------------------------------|-------|--|-------|
| <b>Absorber Box</b>                  | 48    | <b>Dappen Dishes Holder</b>           | 66    | <b>Instrument Oil</b>                 | 19    | <b>Radiation Protection Shield</b>     | 52    |
| <b>Adhesive Spray</b>                |       | <b>Demo Model</b>                     | 68–69 | <b>Intensive Tooth Care</b>           | 70    | <b>Radio Frequency Surgery</b>         | 54–55 |
| <b>for Impression Trays</b>          | 9     | <b>Dental Burner</b>                  | 62–63 | <b>Interdental Brush Holder</b>       | 76    | <b>Rapid Tests</b>                     | 83    |
| <b>Adhesive Wound</b>                |       | <b>Dental Care Chewing Gum</b>        | 83    | <b>Interdental Brushes</b>            | 76    | <b>Reamer</b>                          | 47    |
| <b>Protection Paste</b>              | 51    | <b>Dental Care Model</b>              | 68    |                                       |       | <b>Refill Gas for Burners</b>          | 62    |
| <b>Air Polishing</b>                 | 48    | <b>Dental Care Travel Kit</b>         | 72    | <b>Laser</b>                          | 54–55 | <b>Relaxation Aid</b>                  | 87    |
| <b>Alginate Mixing Device</b>        | 12    | <b>Denture Box</b>                    | 82    | <b>Laser-Bleaching</b>                | 57    | <b>Removal of Crowns/Bridges</b>       | 44    |
| <b>Alginate Remover</b>              | 10    | <b>Denture Brush</b>                  | 82    | <b>Laser Safety Glasses</b>           | 31    | <b>Replacement Brushes</b>             |       |
| <b>Aluminium Oxide Powder</b>        | 48    | <b>Denture Cleaning Device</b>        | 61    | <b>Laser Accessories</b>              | 57    | <b>Interdental Cleaning</b>            | 76    |
| <b>Amalgam Well</b>                  | 45    | <b>Determination</b>                  |       | <b>Learner's toothbrush</b>           | 80    | <b>Rescue Box in Tooth Accidents</b>   | 78    |
| <b>Amine Fluoride Toothpaste</b>     | 73    | <b>of Dentine Thickness</b>           | 55    | <b>Light Polymerisation Device</b>    | 60    | <b>Rhodium-Coated Front Mirror</b>     | 25    |
| <b>Application Aids</b>              | 20    | <b>Disinfection</b>                   | 27    | <b>Lip Retractor/Holder</b>           | 24    | <b>Rinsing Needles</b>                 | 17    |
| <b>Application Brush</b>             | 20    | <b>Disinfection Wipes</b>             | 27    | <b>Luer Needles</b>                   | 16–17 | <b>Root Build-Up Posts</b>             | 46–47 |
| <b>Application Canula</b>            | 16–17 | <b>Disposable Aspiration Canulas</b>  | 33    |                                       |       | <b>Root Canal Cement</b>               | 49    |
| <b>Application Tip</b>               | 20    | <b>Disposable Impression Tray</b>     | 8–9   | <b>Marking Instrument</b>             | 45    | <b>Root Canal Rinsing</b>              | 17    |
| <b>Application Tray</b>              |       | <b>Disposable Mask</b>                | 27    | <b>Marking of X-Ray Films</b>         | 53    | <b>Root Planing</b>                    | 49    |
| <b>for Fluoride Gel</b>              | 67    | <b>Disposable Mouth Mirror</b>        | 25    | <b>Matrix Retainer</b>                | 43    | <b>Rubber Cups</b>                     | 59    |
| <b>Aspiration Box</b>                | 48    | <b>Disposable Toothbrush</b>          | 72/83 | <b>Membrane Container</b>             | 13    | <b>Rubberdam Clamps</b>                | 36–39 |
| <b>Aspiration Canulas</b>            | 32–34 | <b>Disposable Treatment Set</b>       | 22    | <b>Metal Mouth Mirror</b>             | 25    | <b>Rubberdam Cuts</b>                  | 40    |
|                                      |       |                                       |       | <b>Micro Motors</b>                   | 58    | <b>Rubberdam</b>                       | 35–40 |
| <b>Baby Toothbrush</b>               | 80    | <b>Early Diagnosis</b>                | 83    | <b>Micro Nutrient Gel</b>             | 51    |  |       |
| <b>Bipolar-Forceps</b>               | 56    | <b>Electrodes for HF</b>              | 56    | <b>Micro Spiral Brush</b>             | 59    | <b>Safety System Injection</b>         | 18    |
| <b>Bite Blocks</b>                   | 24    | <b>Electronic Vibration Table</b>     | 12    | <b>Millimetre Scale</b>               |       | <b>Sandblasting Device</b>             | 48    |
| <b>Bite Cushion X-Ray</b>            | 52    | <b>Etching Gel</b>                    | 43    | <b>for X-Ray Films</b>                | 53    | <b>Silicone Cleaning Foam</b>          | 27    |
| <b>Bite Cushion</b>                  | 44    | <b>Eye Protection</b>                 | 28–31 | <b>Mirror for Patients</b>            | 25    | <b>Splinting Nets</b>                  | 42    |
| <b>Bleaching Gel</b>                 | 57    |                                       |       | <b>Mixing Bowls</b>                   | 12    | <b>Spray Disinfection</b>              | 27    |
| <b>Bleaching Gelee</b>               | 73    | <b>Face Protection Shield</b>         | 30    | <b>Mouthmask</b>                      | 27    | <b>Stainless Steel Frame</b>           |       |
| <b>Bleaching Handpiece</b>           | 57    | <b>Fibre Post System</b>              | 47    | <b>Mouth Mirrors</b>                  | 25    | <b>for Rubberdam</b>                   | 40    |
| <b>Blunt Needles</b>                 | 16–17 | <b>Filling Material</b>               | 41    | <b>Mouth Opening</b>                  | 24    | <b>Stainless Steel Impression Tray</b> | 10    |
| <b>Bridge Remover</b>                | 44    | <b>Film Holders / Pockets</b>         | 52    | <b>Mouth Rinsing Solution</b>         |       | <b>Sterilization Device</b>            | 61    |
| <b>Brushes for Application</b>       | 20    | <b>Fit Rubberdam Clamps</b>           | 36–39 | <b>with CHX</b>                       | 79    | <b>Storage Boxes</b>                   | 13/80 |
| <b>Budy Care</b>                     | 87    | <b>Fissure Stamp</b>                  | 43    | <b>Mouth Rinsing Tablets</b>          | 66    | <b>Storage of Milk Teeth</b>           | 86    |
| <b>Build-Up Posts</b>                | 46–47 | <b>Fit Rubberdam Latex</b>            | 40    | <b>Multifunction Cart</b>             | 64    | <b>Study Model</b>                     | 68–69 |
| <b>Burner</b>                        | 62–63 | <b>Fit Rubberdam</b>                  | 35–40 |                                       |       | <b>Surface Preparation</b>             | 48    |
|                                      |       | <b>Floss Dispenser</b>                | 74    | <b>Napkin Holders</b>                 | 21    | <b>Surgical Aspiration Cannula</b>     | 34    |
| <b>Calcium Hydroxide Paste</b>       | 43    | <b>Floss Fibres with CHX</b>          | 74    | <b>Needle Box</b>                     | 18    | <b>Syringe Stand</b>                   | 19    |
| <b>Canula for Endodontics</b>        | 16    | <b>Floss</b>                          | 74    | <b>Needles</b>                        | 14–18 | <b>Syringes</b>                        | 19    |
| <b>Canulas</b>                       | 14–18 | <b>Fluoride Gel</b>                   | 67/73 |                                       |       |  |       |
| <b>Caps for Core Build-Up</b>        | 45    | <b>Fluoride Varnish</b>               | 67    | <b>Occlusion Spray</b>                | 45    | <b>Tape Dental Floss</b>               | 74    |
| <b>Carts</b>                         | 64    | <b>Foldable Plastic Frame</b>         | 40    | <b>Over-the-Glass</b>                 |       | <b>Teaching Toothbrush</b>             | 80    |
| <b>Cervical Clamps</b>               |       | <b>Forceps for Rubberdam</b>          | 35    | <b>Protective Eyewear</b>             | 29    | <b>Template for Rubberdam</b>          | 35    |
| <b>for Rubberdam</b>                 | 36    | <b>Frame for Rubberdam</b>            | 40    |                                       |       | <b>Timekeeper</b>                      | 80    |
| <b>Cheek and Lip Retractor</b>       | 24    | <b>Fresh Breath</b>                   | 79    | <b>Parallel Drilling Aid</b>          |       | <b>Tips and Connecting Pieces</b>      |       |
| <b>Cheek Holder</b>                  | 24    | <b>Fully Synthetic</b>                |       | <b>for Implants</b>                   | 50    | <b>for Aspiration Canulas</b>          | 32    |
| <b>Cheating Gum</b>                  | 83    | <b>Maintenance Product</b>            | 61    | <b>Partial Impression</b>             | 9     | <b>Tissue Adhesive</b>                 | 50    |
| <b>Children's Toothbrushes</b>       | 81    |                                       |       | <b>Paste Needles</b>                  | 16–17 | <b>Tongue Cleaner</b>                  | 82    |
| <b>Chlorhexidine Dental Floss</b>    | 74    | <b>Gas for Burner</b>                 | 62    | <b>Patient Mirror</b>                 | 25/68 | <b>Tongue Gel</b>                      | 82    |
| <b>Chlorhexidine</b>                 |       | <b>Glass Fibre Band</b>               | 42    | <b>Patient Service</b>                | 68–69 | <b>Tooth Picks</b>                     | 75    |
| <b>Interdental Brushes</b>           | 75    | <b>Glass Fibre Build-Up Post</b>      | 46–47 | <b>Pen for Marking</b>                |       | <b>Tooth Rinsing Solution</b>          | 79    |
| <b>Chlorhexidine</b>                 |       | <b>Glasses</b>                        | 28–31 | <b>of X-Ray Pictures</b>              | 53    | <b>Tooth Whitening</b>                 | 57/70 |
| <b>Mouth Rinsing Solution</b>        | 79    | <b>Grid Bows</b>                      | 42    | <b>Phosphoric Acid Gel</b>            | 43    | <b>Toothbrush Holders</b>              | 81    |
| <b>Chlorhexidine Paste</b>           | 67    |                                       |       | <b>Pipettes</b>                       | 21    | <b>Toothbrushes</b>                    | 71–72 |
| <b>Clamp Forceps for Rubberdam</b>   | 35    | <b>Hand Pieces</b>                    |       | <b>Plaque Test Tablets</b>            | 78    | <b>Toothbrushes for Children</b>       | 81    |
| <b>Cleaning Brush</b>                | 26    | <b>and Contra-Angles</b>              | 58    | <b>Plastic Aspiration Canulas</b>     | 32–34 | <b>Tooth-Coloured Repair</b>           |       |
| <b>Cleaning Brush for Canulas</b>    | 34    | <b>Hand Cleaning Brush</b>            | 26    | <b>Plastic Caps for Core Build-Up</b> | 45    | <b>and Universal Material</b>          | 41    |
| <b>Cleaning Foam</b>                 | 27    | <b>Hand Mirror</b>                    | 25/68 | <b>Plastic Impression Tray</b>        | 8–9   | <b>Toothpaste</b>                      | 70/73 |
| <b>Cleaning of Impression Trays</b>  | 10    | <b>Hand Pieces</b>                    | 58    | <b>Pointed Brush</b>                  | 77    | <b>Toys</b>                            | 84–86 |
| <b>Cleaning Solution</b>             | 26    | <b>Hand Puppets with Dentition</b>    | 84    | <b>Polymerisation Device</b>          | 60    | <b>Transport and Storage Box</b>       | 13/80 |
| <b>Cold Compress</b>                 | 26    | <b>Headphones</b>                     | 87    | <b>Post Build-Up</b>                  | 46–47 |  |       |
| <b>Cold Spray</b>                    | 26    | <b>Holder for Dental Floss</b>        | 74    | <b>Postoperative Treatment</b>        | 51    | <b>Underlinings</b>                    | 43    |
| <b>Collector-free AC motor</b>       | 60    | <b>Holder for Interdental Brushes</b> | 76    | <b>Pouches for X-Ray Pictures</b>     | 53    | <b>Universal HF Surgery Unit</b>       | 54    |
| <b>Colouring Tablet</b>              |       | <b>Hourglass</b>                      | 80    | <b>Powder for</b>                     |       | <b>User reports</b>                    | 88/89 |
| <b>for Dental Plaque</b>             | 78    | <b>Hydro Impression</b>               |       | <b>Sandblasting Devices</b>           | 48    | <b>Uvex Glasses</b>                    | 28/30 |
| <b>Contact Point Gauge</b>           | 45    | <b>Material/Colloid</b>               | 11    | <b>Practice Cleaning Foam</b>         | 27    |  |       |
| <b>Container for Dental Floss</b>    | 74    |                                       |       | <b>Preparation, Measurement</b>       | 65    | <b>Vibrating Unit</b>                  | 12    |
| <b>Container for Disinfection</b>    | 21    | <b>Implant Impression Tray</b>        |       | <b>Prophy Tips</b>                    | 59    |  |       |
| <b>Container for Needle Disposal</b> | 18    | <b>with Foil Technique</b>            | 8     | <b>Prophylaxis Hand Pieces</b>        |       | <b>Wound Dressing</b>                  | 51    |
| <b>Contra-Angles</b>                 | 58    | <b>Implant Sealing</b>                | 11    | <b>and Contra-Angles</b>              | 28    |  |       |
| <b>Core Build-Up</b>                 | 45    | <b>Impression Tray Cleaning</b>       | 10    | <b>Prophylaxis Paste</b>              | 66    | <b>X-Ray Film Viewer</b>               | 53    |
| <b>Crown and Bridge Remover</b>      | 44    | <b>Impression Tray</b>                | 8–10  | <b>Protective Eyewear</b>             | 28–31 | <b>X-Ray Holder</b>                    | 52    |
| <b>Cups for Tooth Cleaning</b>       | 66    | <b>Impressions</b>                    | 8–12  | <b>Pulp Build-Up Post</b>             | 46–47 | <b>X-Ray Shield</b>                    | 52    |
| <b>Curettage</b>                     | 49    | <b>Indicator Solution</b>             |       | <b>Punch for Rubberdam</b>            | 35    | <b>Xylitol</b>                         | 71    |
|                                      |       | <b>for Dental Plaque</b>              | 78    |                                       |       |  |       |
|                                      |       | <b>Injection Canulas</b>              | 14–18 |                                       |       |  |       |

Page 11

### GapSeal®

*The decisive weapon against periimplantitis*

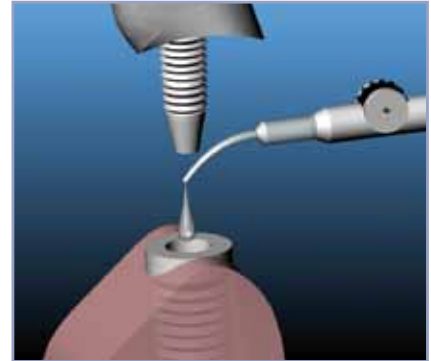

Page 54

### LaserHF® "comfort"

*Laser and HF technology combination device*

HF: Cutting      Therapeutic laser      HF: Coagulating      Diode laser



Page 71

### Xylitol Drops

*Oral care sweets with 100 % natural Xylitol – sugar free*



Cherry      Melone      Mint





halitosis spray  
*Oral care spray for immediate fresh breath*



Page 79

Page 83



PerioMarker®

*Rapid Oral health test for parodontitis early detection and risk assumption*

ImplantMarker

*Rapid test of implant health for early detection of peri-implantitis with risk assumption*

Page 86

Miratoi® Nr. 17

*Fingerboards*



Miratoi® Nr. 15

*Mini Ponies*



Page 87



Comfort Dreams

*Relaxation headphones for patients*

# Miratray® Implant



## Implant impression tray with foil technique

- Saves you and your patient an additional patient visit and laboratory cost
- Controllable and safe impression taking with clear view of implant posts
- Clean impression is taken as foil meets precisely at implant posts
- No overflowing impression material
- Customisable, user-friendly and cost-effective
- Available in three sizes for maxilla and mandible (dentulous and edentulous)
- Suitable for all implant impression materials and implant systems

"Making an individual tray in laboratory is no longer necessary = time saving (appointment) and cost saving for the patient."  
Petra Weidenmüller, Magdeburg



Video

| Article description                                      | Size   | Content | REF     |
|--|--------|---------|---------|
| Intro Kit 6 x 1 piece (Upper/Lower small, medium, large) |        |         | 101 250 |
| Upper, S1  | small  | 6 pcs.  | 101 251 |
| Upper, S2  | medium | 6 pcs.  | 101 252 |
| Upper, S3  | large  | 6 pcs.  | 101 253 |
| Lower, I1  | small  | 6 pcs.  | 101 254 |
| Lower, I2  | medium | 6 pcs.  | 101 255 |
| Lower, I3  | large  | 6 pcs.  | 101 256 |

# Miratray®

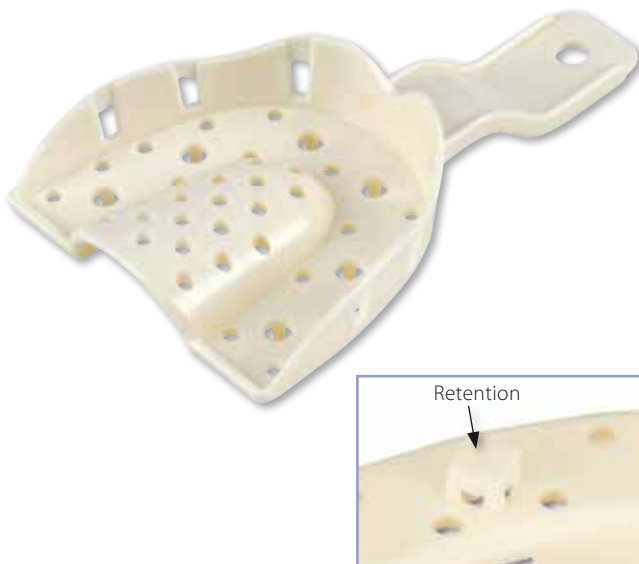

## Disposable impression tray made of white plastic

- Inexpensive and solid, mouldable when heated
- Excellent retention of the impression material by special "retention baskets"
- Practical: can be labelled with felt-tip pen
- Complete tray available in six sizes

| Article description | Size   | Content | REF     |
|---------------------|--------|---------|---------|
| Upper, S3           | large  | 50 pcs. | 101 142 |
| Upper, S2           | medium | 50 pcs. | 101 141 |
| Upper, S1           | small  | 50 pcs. | 101 140 |
| Lower, I3           | large  | 50 pcs. | 101 145 |
| Lower, I2           | medium | 50 pcs. | 101 144 |
| Lower, I1           | small  | 50 pcs. | 101 143 |
| Upper, S3           | large  | 12 pcs. | 101 172 |
| Upper, S2           | medium | 12 pcs. | 101 171 |
| Upper, S1           | small  | 12 pcs. | 101 170 |
| Lower, I3           | large  | 12 pcs. | 101 175 |
| Lower, I2           | medium | 12 pcs. | 101 174 |
| Lower, I1           | small  | 12 pcs. | 101 173 |

S = Superior I = Inferior

## Assortment I

50 complete/partial trays in nine designs, assorted:

Shape: I2 S2 S3 S1 I1 I3 PL PR PM

Quantity: 10 10 5 5 5 5 3 3 4

| Article description    | Content | REF     |
|------------------------|---------|---------|
| Assortment I, assorted | 50 pcs. | 101 149 |



### For single impressions of crowns and small bridges

- Inexpensive disposable plastic tray
- Limited mouldability when slightly heated
- Can easily be slid onto corrugated tweezers
- Excellent for patients, avoids an urge to gag
- Saves impression materials

| Article description | Content | REF     |
|---------------------|---------|---------|
| Miratrax Mini       | 50 pcs. | 101 102 |

### Partial plastic impression tray in three shapes

- Excellent for patients feeling an urge to gag
- Saves impression material

| Article description | Content  | REF     |
|---------------------|----------|---------|
| Bag, PR right       | 12 pcs.  | 101 178 |
| Box, PR right       | 100 pcs. | 101 148 |
| Bag, PL left        | 12 pcs.  | 101 176 |
| Box, PL left        | 100 pcs. | 101 146 |
| Bag, PM middle      | 12 pcs.  | 101 177 |
| Box, PM middle      | 100 pcs. | 101 147 |

| Article description                  | Content  | REF     |
|--------------------------------------|----------|---------|
| Assortment II, all 3 shapes assorted | 100 pcs. | 101 151 |

### Autoclavable plastic impression tray

- Transparent, limited mouldability slightly heated, yet sturdy
- High retention of the impression material is obtained by special "retention baskets"
- Practical: can be labelled with felt-tip pen
- Available in three sizes

| Article description | Size   | Content               | REF     |
|---------------------|--------|-----------------------|---------|
| Set sortiert        |        | 6 pcs. (je 3 x OK/UK) | 101 155 |
| Upper, AS 1         | small  | 6 pcs.                | 101 156 |
| Upper, AS 2         | medium | 6 pcs.                | 101 157 |
| Upper, AS 3         | large  | 6 pcs.                | 101 158 |
| Lower, AI 1         | small  | 6 pcs.                | 101 160 |
| Lower, AI 2         | medium | 6 pcs.                | 101 161 |
| Lower, AI 3         | large  | 6 pcs.                | 101 162 |

AS = Autoclavable Superior AI = Autoclavable Inferior

### Adhesive spray

- For better adhesion of the impression material to both, plastic and metal trays
- Universally usable, for alginates, hydrocolloids, etc.

| Article description | Content | REF     |
|---------------------|---------|---------|
| Miratrax Spray      | 225 ml  | 554 210 |

## Miratrax® Mini



## Miratrax® Partial



### Assortment II

100 partial trays in three shapes, assorted:

Shape: PL PR PM

Quantity: 33 33 34

## Miratrax® 140°



## Miratrax® Spray



## Algilock®



### Extremely durable impression tray

- For dentulous jaws
- High-quality, corrosion-resistant stainless steel
- High durability, highest shape stability and long-term good appearance
- "Retention rims" hold the impression material without adhesives
- Laser-welded handles and ridges for a solid interconnection
- Autoclavable without loss of quality
- Only Algilock offers such a unique model variety and solid top quality
- On request, Algilock is available for maxilla and mandible as:
  - Algilock partial (perforated/non-perforated)
  - Algilock pedo (orthodontology)
  - Algilock edentulous

| Article description                 | Size     | USA | REF     |
|-------------------------------------|----------|-----|---------|
| Upper, BS 5                         | xx-large | U11 | 101 006 |
| Upper, BS 3                         | x-large  | U12 | 101 004 |
| Upper, BS 2A                        | large    | U13 | 101 042 |
| Upper, BS 2                         | medium   | U14 | 101 003 |
| Upper, BS 1                         | small    | U15 | 101 002 |
| Lower, BI 5                         | xx-large | L11 | 101 011 |
| Lower, BI 3                         | x-large  | L12 | 101 009 |
| Lower, BI 2A                        | large    | L13 | 101 043 |
| Lower, BI 2                         | medium   | L14 | 101 008 |
| Lower, BI 1                         | small    | L15 | 101 007 |
| Set mit 10 trays (5 upper, 5 lower) |          |     | 101 001 |

BS = Dentulous Superior BI = Dentulous Imperior

## Algilock® Perforated



| Article description                | Size    | USA | REF     |
|------------------------------------|---------|-----|---------|
| Upper, PS 6                        | x-large | 7   | 101 036 |
| Upper, PS 5                        | large   | 5   | 101 034 |
| Upper, PS 4                        | medium  | 4   | 101 033 |
| Upper, PS 3                        | small   | 1   | 101 032 |
| Lower, PI 6                        | x-large | 24  | 101 041 |
| Lower, PI 5                        | large   | 22  | 101 039 |
| Lower, PI 4                        | medium  | 21  | 101 038 |
| Lower, PI 3                        | small   | 20  | 101 037 |
| Set mit 8 trays (4 upper, 4 lower) |         |     | 101 031 |

PS = Perforated Superior PI = Perforated Imperior

## Algilock® Cleaner Plus

### Alginate remover

- Cleaning in dipping bath without mechanical impact, no ultrasound, no scratching
- Decomposes the organic structure of the impression material, no aggressive or caustic effect, no corrosion
- Even after several cleanings impression trays do not tarnish
- Bio-degradable and pH-neutral, phosphate-free, pleasant smell
- For approx. 500 trays

Easily removes plaster and alginates from impression trays, instruments and spatulas. No laborious and time-consuming cleaning, simply add 50 g to one litre of warm water and leave for approx. 15 – 30 minutes. May also be used in an ultrasonic unit. Not suitable for aluminium trays.

| Article description   | Content | REF     |
|-----------------------|---------|---------|
| Algilock Cleaner Plus | 1000 g  | 554 104 |



## The decisive weapon against periimplantitis

- Seals implant gaps and hollow spaces
- Durably stops infiltration of germs into the hollow spaces
- Eliminating risk of reinfection of periimplant tissue
- Effectively avoids a main reason for periimplantitis
- Successful 16-year clinical study of the University Düsseldorf, Germany
- Quick and easy handling and application
- Each carpule supports enough material for 2 – 3 implants

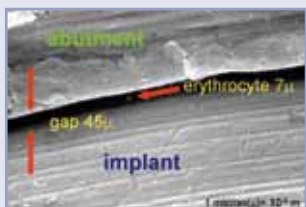

| Article description                    | REF     |
|--|---------|
| GapSeal set (applicator + 10 tips)     | 152 041 |
| GapSeal refill (10 tips, 0.06 ml each) | 152 040 |
| Applicator                             | 152 042 |

### Gap Sealing against Periimplantitis

Out of manufacturing reasons, gaps and hollow spaces between implant and structures are inevitable for all compound implants.

These gaps can be minimized depending on fabrication precision. However, they are never completely bacteria-proof and in an open connection with the bacteria- and fungi-settled oral cavity. The spectrum of germs settling in the hollow spaces consists of a large quantity of gram-negative, mostly anaerobic bacteria, as it is the case with periimplantitis. These humid and warm implant interiors offer an ideal milieu for bacteria growth and partly also cause fungi affection. Already 16 years ago, the Clinic for Oral and Maxillofacial Surgery of the Heinrich-Heine University, Düsseldorf, Germany under the direction of Prof. Dr. Dr. Fritzemeier has started to find a solution to this problem. The gap between abutment and implant averages „only“ 45 µm, whereas most of the relevant bacteria have a size of between 0.5 µm and 4 µm.

Based on extensive studies and tests, a material was developed sealing all capillary gaps and interior spaces of the compound implant bacteria-proof.

GapSeal is based on a special silicone matrix ingredient composition, which creates a barrier effectively preventing infiltration by bacteria. It is used directly after fitting of the implant with the first fixing of the locking screw. So the implant is durably protected against colonization by bacteria, viruses and fungi from the very beginning. Gap-Seal is most easy in application as the material is offered in small portion tips, together with a special applicator.

GapSeal seals the gaps and hollow spaces, which are to be found in every compound implant, thus effectively and durably avoiding an colonization of germs into these hollow spaces and eliminating the risk of re-infection of the periimplant tissue, the main reason for periimplantitis.



The implants are thoroughly covered with GapSeal immediately after they are placed, during the first turns of the locking screw.

## GapSeal®

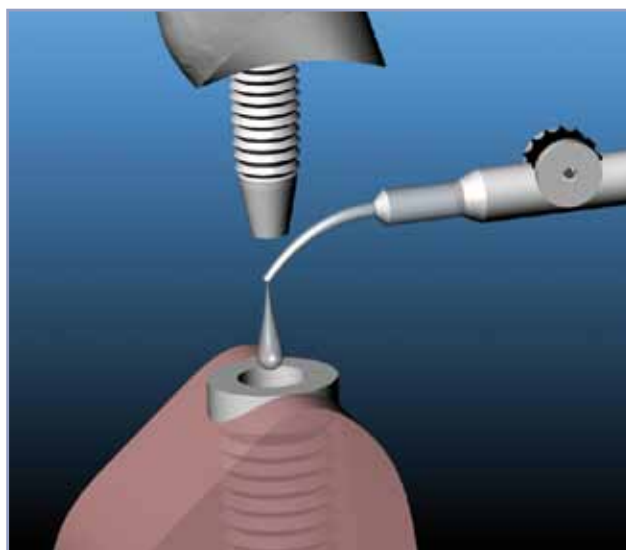

After removing the closure cap GapSeal is directly applied by simple turning the transport screw.

## Mirabol®



## Flex-O-Bol



### Green flexible mixing bowls

- Easy to clean
- For alginate, plaster, etc.
- Flexible material of first-class quality
- Available in three sizes/heights

| Article description   | ø     | Hight | REF     |
|-----------------------|-------|-------|---------|
| No. 1 (large)         | 12 cm | 9 cm  | 304 331 |
| No. 2 (x-large)       | 13 cm | 11 cm | 304 332 |
| No. 3 (jumbo)         | 17 cm | 13 cm | 304 333 |
| a) Mirabol spatula    |       |       | 304 316 |
| b) Plaster spatula RS |       |       | 304 314 |

### Classic, dark green mixing bowls

- Easy to clean and flexible
- For alginate, plaster etc.
- Available in 4 sizes

| Article description | ø       | Hight  | REF     |
|---------------------|---------|--------|---------|
| No. 1/4 (small)     | 8 cm    | 5.5 cm | 304 320 |
| No. 1/2 (medium)    | 10.5 cm | 7.5 cm | 304 321 |
| No. 1 (large)       | 12 cm   | 9 cm   | 304 322 |
| No. 2 (x-large)     | 14 cm   | 11 cm  | 304 323 |

## Algimix



### Alginat mixing device

- Reliable, solid stainless steel body, maintenance-free
- Minimal time exposure
- Electronically controlled, even stirring movement mixes powder and liquid to an absolutely homogeneous bubble-free alginate mass
- High-quality, durable mixing bowl made of flexible plastic
- Stirring speed adjustable in two steps

#### Technical data

|                              |                   |
|------------------------------|-------------------|
| Voltage:                     | 230 V             |
| Power consumption:           | 100 W             |
| Fuse:                        | 1.25 A            |
| Size incl. bowl (W x H x D): | 13,5 x 23 x 20 cm |
| Weight with (without) bowl:  | 3.7 kg (3.5 kg)   |

| Article description          | REF     |
|------------------------------|---------|
| Device with bowl and spatula | 452 045 |
| Bowl only                    | 452 046 |
| Spatula only                 | 304 317 |

## Mirator 2000



### Electronically adjustable vibrator

- Continuously variable to up to 6,000 vibrations/min.
- Sturdy and powerful
- Worktop available separately upon request

#### Technical data

|                    |                      |
|--------------------|----------------------|
| Worktop:           | approx. 160 x 155 mm |
| Voltage:           | 220/240 V, 50/60 Hz  |
| Power consumption: | max. 100 W           |
| Safety fuse:       | 2.0 A                |
| Weight:            | 3.0 kg               |

| Article description | REF     |
|---------------------|---------|
| Mirator 2000        | 401 344 |

### Patented transport and storage box

- With two elastic, transparent membranes
- Ideal storage to safely send pieces of high-quality work
- Long durability due to high-quality material
- Stackable

| Article description                                      | REF     |
|--|---------|
| Medium: for bridges, partial dentures, attachments, etc. | 304 602 |
| Large: for 1 model, prosthesis, larger objects, etc.     | 304 601 |



### Transport and storage box with inside membranes

- Two membrane foils hold the contents gently and well visible
- Safety lock
- No rattling due to two membrane foils gently holding even smallest pieces
- Stackable

| Article description                              | REF     |
|--|---------|
| Small: set with 12 pcs. for crowns, inlays, etc. | 304 603 |
| XXL: for 2 models                                | 304 605 |

### Solid transport and storage box

- For prosthesis, orthodontic works, etc.
- Impact-proof, safe snap lock and small ventilation holes
- Ideal advertising medium with your name and address (from 500 pcs.)

**This article can be delivered with your advertising imprint. Please ask for a quotation.**

| Article description | Content | REF     |
|---------------------|---------|---------|
| Dento Box I, white  | 12 pcs. | 355 148 |
| Dento Box II, white | 10 pcs. | 355 141 |
| Dento Box II, blue  | 10 pcs. | 355 142 |
| Dento Box II, pink  | 10 pcs. | 355 143 |

Dento Box with hang cord see page 80.

## Membranbox

### Medium and Large



Medium (W x H x D)  
8.5 x 2.2 x 9 cm



Large (W x H x D)  
13.2 x 7.1 x 8.3 cm

### Small and XXL

Small (W x H x D)  
4 x 1.9 x 4 cm



XXL (W x H x D)  
19.2 x 4.8 x 9.2 cm

## Dento Box® I + II



Dento Box II: Height 4 cm













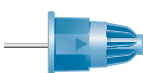

Dento Box I: Height 2.5 cm











# Injection

## Carpule





|                                       |   |             |   |
|---------------------------------------|---|-------------|---|
| <b>Miraject 17/42*</b><br>REF 254 200 |  | 0.5 x 35 mm |  |
| <b>Miraject 17/23*</b><br>REF 254 201 |  | 0.5 x 21 mm |  |
| <b>Miraject 30/42*</b><br>REF 254 202 |  | 0.4 x 35 mm |  |
| <b>Miraject 30/23*</b><br>REF 254 203 |  | 0.4 x 21 mm |  |
| <b>Miraject 40/23*</b><br>REF 254 204 |  | 0.3 x 21 mm |  |
| <b>Miraject 40/10</b><br>REF 254 205  |  | 0.3 x 10 mm |  |

## Luer



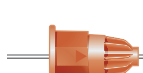

|   |   |             |   |
|---|---|-------------|---|
| <b>Miraject Luer 17/42</b><br>REF 254 210 |  | 0.5 x 42 mm |  |
| <b>Miraject Luer 17/23</b><br>REF 254 211 |  | 0.5 x 23 mm |  |
| <b>Miraject Luer 30/42</b><br>REF 254 212 |  | 0.4 x 42 mm |  |
| <b>Miraject Luer 30/23</b><br>REF 254 213 |  | 0.4 x 23 mm |  |

# Application

## Standard

|  |   |                 |
|--|---|-----------------|
| <b>Miraject P (Carpule)</b><br>REF 254 206       |  | 0.8 x 25 mm/21G |
| <b>Miraject P Super (Carpule)</b><br>REF 254 207 |  | 0.9 x 32 mm/20G |
| <b>Miraject PL Super (Luer)</b><br>REF 254 214   |  | 0.9 x 22 mm/20G |
| <b>Miraject Endo Luer</b><br>REF 254 222         |  | 0.3 x 40 mm/30G |
| <b>Miraject Endo Luer</b><br>REF 254 215         |  | 0.5 x 40 mm/25G |

## Endotec Luer

|   |   |                 |
|---|---|-----------------|
| <b>Miraject Endotec Luer</b><br>REF 254 216 |  | 0.8 x 25 mm/21G |
| <b>Miraject Endotec Luer</b><br>REF 254 217 |  | 0.6 x 25 mm/23G |
| <b>Miraject Endotec Luer</b><br>REF 254 218 |  | 0.5 x 25 mm/25G |
| <b>Miraject Endotec Luer</b><br>REF 254 228 |  | 0.4 x 25 mm/27G |
| <b>Miraject Endotec Luer</b><br>REF 254 219 |  | 0.3 x 25 mm/30G |

## Endotec Luer Duo

|  |   |                 |  |   |                 |
|--|---|-----------------|--|---|-----------------|
| <b>Miraject Endotec Duo</b><br>REF 254 230 |  | 0.6 x 25 mm/23G | <b>Miraject Endotec Duo</b><br>REF 254 232 |  | 0.4 x 25 mm/27G |
| <b>Miraject Endotec Duo</b><br>REF 254 231 |  | 0.5 x 25 mm/25G | <b>Miraject Endotec Duo</b><br>REF 254 233 |  | 0.3 x 25 mm/30G |

## The injection canula on the dental market

- The classic disposable canula for cylinder ampoules
- Has been the hallmark of quality for more than 45 years: over 400 million Miraject canulas meeting highest quality standards
- Manufactured under strictest quality controls
- Meets the highest requirements of injection hygiene, every needle having a sterility control seal
- Triple lancet cut – almost painless
- Injection mark – orientation
- Silicone coating – ideal gliding behaviour
- Convenient handling and waste disposal
- $\varnothing$  0.5mm = red seal,  $\varnothing$  0.4 mm = yellow seal,  $\varnothing$  0.3 mm = green seal

**Tip:** Compatible with the Miramatic safety syringe system

| Type  | $\varnothing$ | Gauge | Length | REF     |
|-------|---------------|-------|--------|---------|
| 17/42 | 0.5 mm        | 25    | 35 mm  | 254 200 |
| 17/23 | 0.5 mm        | 25    | 21 mm  | 254 201 |
| 30/42 | 0.4 mm        | 27    | 35 mm  | 254 202 |
| 30/23 | 0.4 mm        | 27    | 21 mm  | 254 203 |
| 40/23 | 0.3 mm        | 30    | 21 mm  | 254 204 |

Short canula for intraligamentary anaesthesia (not suitable for the Miramatic system):

| Type  | $\varnothing$ | Gauge | Length | REF     |
|-------|---------------|-------|--------|---------|
| 40/10 | 0.3 mm        | 30    | 10 mm  | 254 205 |



With injection aid

## Injection canula with plastic Luer cone

- For injection solutions from an ampoule
- For any conventional disposable syringe
- Individually and sterile packed
- Colour-coded

**Pack with 100 pieces**

| Type  | $\varnothing$ | Gauge | Length | REF     |
|-------|---------------|-------|--------|---------|
| 17/42 | 0.5 mm        | 25    | 42 mm  | 254 210 |
| 17/23 | 0.5 mm        | 25    | 23 mm  | 254 211 |
| 30/42 | 0.4 mm        | 27    | 42 mm  | 254 212 |
| 30/23 | 0.4 mm        | 27    | 23 mm  | 254 213 |

## Miraject®

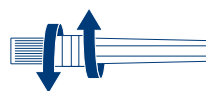

With paper seal

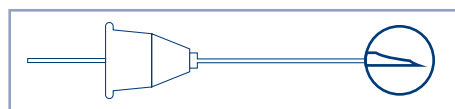

## Miraject® Luer

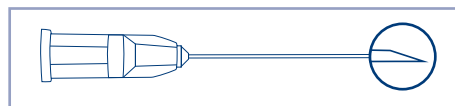

## Miraject® P / P Super

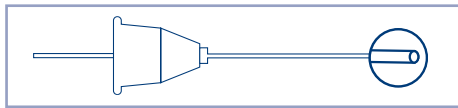

### Canula for paste-like materials

- Blunt, bendable and individually sterile packed
- For cylinder ampoules
- Colour-coded

Pack with 100 pieces

| Type             | ∅      | Gauge | Length | REF     |
|------------------|--------|-------|--------|---------|
| Miraject P       | 0.8 mm | 21    | 25 mm  | 254 206 |
| Miraject P Super | 0.9 mm | 20    | 32 mm  | 254 207 |

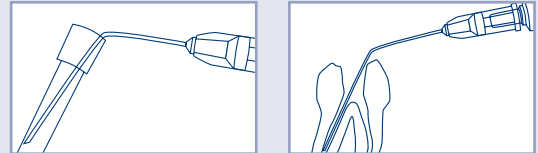

## Miraject® PL Super

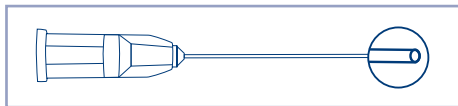

### Blunt Luer application canula

- For application of liquids, gels and for rinsing wider root canals
- Sterile packed
- Bendable
- For syringes with Luer tip
- Colour-coded

Pack with 100 pieces

| Type              | ∅      | Gauge | Length | REF     |
|-------------------|--------|-------|--------|---------|
| Miraject PL Super | 0.9 mm | 20    | 22 mm  | 254 214 |

## Miraject® Endo Luer

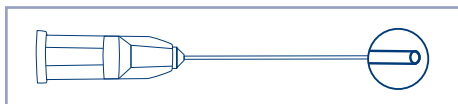

### Blunt, bendable canula for endodontics

- Application of liquids and pastes into the root canal
- Finest controllable measures
- In two sizes: 0.3 mm (30 gauge) and 0.5 mm (25 gauge), easy-to-insert into the root canal
- For syringes with Luer tip
- Colour-coded

Pack with 100 pieces

| Type                       | ∅      | Gauge | Length | REF     |
|----------------------------|--------|-------|--------|---------|
| Miraject Endo Luer, fine   | 0.3 mm | 30    | 40 mm  | 254 222 |
| Miraject Endo Luer, medium | 0.5 mm | 25    | 40 mm  | 254 215 |



### Convenient rinsing system for root canals, etc.

- Consisting of disposable syringe and blunt canula, sterile packed
- Syringe: for 2 ml liquid, with 1/10 ml calibration
- Canula: blunt, fine, long and bendable canula (0.5 mm/25 G x 32 mm)

Pack with 50 disposable syringes and 50 canulas

| Type                | ø      | Gauge | Length | REF     |
|---------------------|--------|-------|--------|---------|
| Miraject Endo Rinse | 0.5 mm | 25    | 32 mm  | 254 220 |

### Special canula for rinsing with lateral opening

- Extra gentle, effective rinsing process
- Lateral opening avoids pressure on the apex
- Round canula end – low perforation risk
- Also ideal for gentle rinsing of periodontal pockets
- Sterile packed
- For syringes with Luer tip

Pack with 25 pieces

| Type                  | ø      | Gauge | Length | REF     |
|-----------------------|--------|-------|--------|---------|
| Miraject Endotec Luer | 0.8 mm | 21    | 25 mm  | 254 216 |
| Miraject Endotec Luer | 0.6 mm | 23    | 25 mm  | 254 217 |
| Miraject Endotec Luer | 0.5 mm | 25    | 25 mm  | 254 218 |
| Miraject Endotec Luer | 0.4 mm | 27    | 25 mm  | 254 228 |
| Miraject Endotec Luer | 0.3 mm | 30    | 25 mm  | 254 219 |

### Special canula with two lateral openings

- Extra gentle, effective rinsing process
- Two lateral openings avoid pressure on the apex
- Round canula end – low perforation risk
- Also ideal for gentle rinsing of periodontal pockets
- Sterile packed
- For syringes with Luer tip

Pack with 25 pieces

| Type                 | ø      | Gauge | Length | REF     |
|----------------------|--------|-------|--------|---------|
| Miraject Endotec Duo | 0.6 mm | 23    | 25 mm  | 254 230 |
| Miraject Endotec Duo | 0.5 mm | 25    | 25 mm  | 254 231 |
| Miraject Endotec Duo | 0.4 mm | 27    | 25 mm  | 254 232 |
| Miraject Endotec Duo | 0.3 mm | 30    | 25 mm  | 254 233 |

## Miraject® Endo Rinse

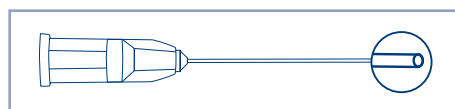

## Miraject® Endotec Luer

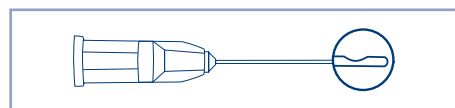

## Miraject® Endotec Duo

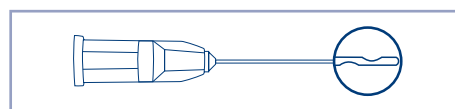

## Miramatic®

**Innovative safety syringe system with single-handed operation**

- "No-touch system": No risk for the dentist and assistant to come into direct contact with the blood- and saliva-contaminated needle
- No risk of infection with HIV, hepatitis and other germs because of "re-capping" or disposing used canulas
- No injury risk from used canulas
- No screwing on and off necessary, more than 70% time saving

Further information on [www.miraject.de](http://www.miraject.de)

**The Miramatic Safety-Set:** 1 syringe, 3 boxes, 1 table fixing device and 1 Pack of Miraject-needles (Typ 30 / 23)

| Article description       | REF     |
|---------------------------|---------|
| Set with 1-ring syringe   | 355 471 |
| Set with 3-ring syringe   | 355 469 |
| Set with T-handle syringe | 355 473 |
| Set with Miramatic Aspi   | 355 496 |

"The "No-touch-system" has convinced me. In our practice we have been familiar with the risk of getting into contact with blood- and saliva contaminated needles for many years and have reduced the risk of infection to a minimum. Following the injection, the safety stand ensures that the syringe is on hand and can be disposed of contact-free + stored safely after use."  
Dr. Gabriele Schmeichel, Lückstedt

Makes it easy to adhere to the EU-Directive 20/32/EU regarding prevention of injuries caused by sharp/pointed instruments.

**Patented disposal box**

- With automatic lid, opening itself at the push of a button
- Disposal of used canulas and other products contaminated with blood and saliva, such as scalpels, disposable syringes and similar
- Absolutely safe storage due to firmly fixed lid with safety lock
- Opening for unlocking the Miramatic syringe and for disposal of the Miraject canulas
- The opening can be enlarged gradually by pushing out the flap
- Table fixing device for firm placing of the box

| Article description             | REF     |
|---------------------------------|---------|
| 5 boxes, 1 table fixing device  | 355 468 |
| Table fixing device, separately | 355 472 |

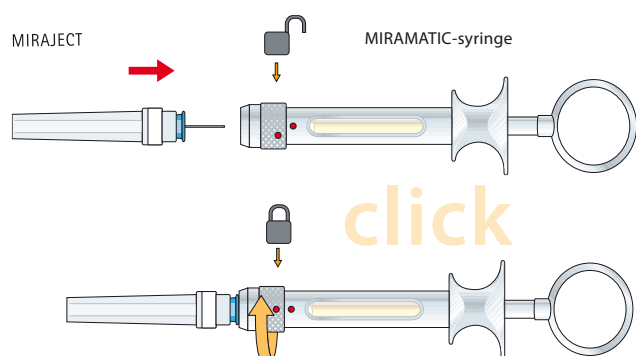
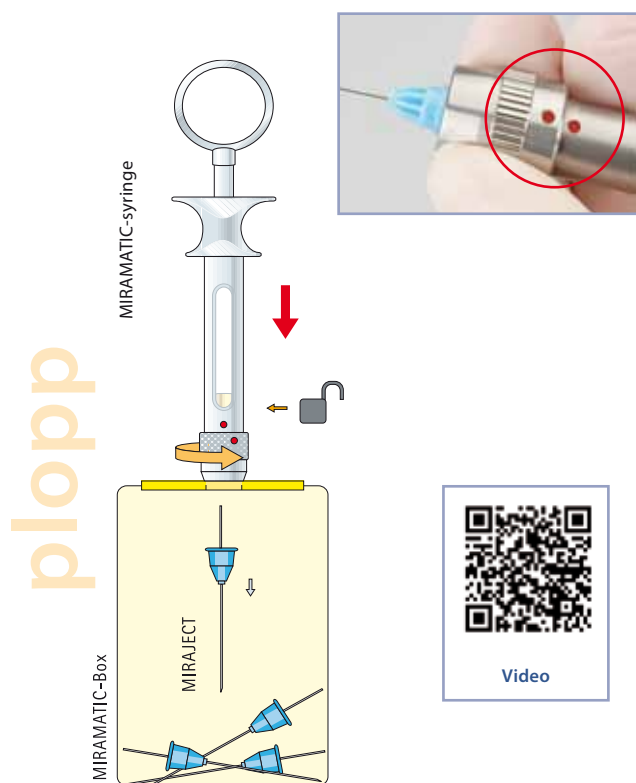

## Miramatic® -Box



## Syringes for the Miramatic system

- Entirely made of stainless steel with three handle designs available
- Matt finish surfaces prevent reflections and protect against scratches
- With aspiration potential
- Autoclavable

| Article description            | REF     |
|--------------------------------|---------|
| 1-ring                         | 355 464 |
| 3-ring                         | 355 467 |
| T-handle                       | 355 474 |
| Miracare instrument oil 100 ml | 554 112 |

We recommend Miracare instrument oil for maintaining the Miramatic head.

## Self-aspirating syringe for the Miramatic system

- For conduction and infiltration anaesthesia
- Without aspiration hook, no tension at the syringe flask in counter direction
- Aspiration by light pressure/release of the syringe flask
- Autoclavable

| Article description | REF     |
|---------------------|---------|
| Miramatic Aspi      | 355 495 |

## Solid safety stand for injection syringes and rinsing canulas

- No risk of injury from needles lying open on the cart
- One-hand re-capping reduces injury risk
- Syringe sits upright in its own protective cover
- Fixing clamp holds the protective cover tightly
- Stainless steel, approx. 220 g

**Tip:** Perfect complement to the Miramatic system

| Article description   | REF     |
|-----------------------|---------|
| Miramatic Holder Plus | 355 466 |

## Miramatic® Syringes



## Miramatic® Aspi



## Miramatic® Holder Plus



## Apply-Tips®



with dispenser aid



### Fine application tips

- For precise application of liquids and pastes
- Bendable ends for hard-to-access areas
- Economic use of expensive materials (such as bondings, medicaments, etc.)
- Acid-resistant against bonding and other materials
- Hygienic dispenser box for single removal
- Available in three sizes

| Article description               | Content      | REF     |
|-----------------------------------|--------------|---------|
| Medium – regular, blue handle     | 100 pcs.     | 605 510 |
| Medium – regular, blue handle     | 5 x 100 pcs. | 605 511 |
| Fine – fine, white handle         | 100 pcs.     | 605 512 |
| Fine – fine, white handle         | 5 x 100 pcs. | 605 513 |
| Conical – conical, green handle   | 100 pcs.     | 605 514 |
| Conical – conical, green handle   | 5 x 100 pcs. | 605 515 |
| Apply-Tips dispenser for 500 pcs. | unfilled     | 605 516 |

## Mirabrush®



### Bendable application brush

- One-piece disposable brush
- Bendable: can be bended into any angle
- Time-saving: no changing of brushes
- Safe: no danger of cross infection
- Yellow handle = pointed brush, exact application
- Blue handle = flat brush, larger surfaces

#### Dispenser pack

| Article description           | Content  | REF     |
|-------------------------------|----------|---------|
| Regular 10 cm, yellow/pointed | 100 pcs. | 605 460 |
| Regular 10 cm, blue/flat      | 100 pcs. | 605 461 |

## Pick up Stick



### Adhesive application aid

- Bendable stick with adhesive wax tip
- Ideal for quick and precise pick-up of crowns, inlays, veneers



| Article description | Content | REF     |
|---------------------|---------|---------|
| Pick up Stick       | 30 pcs. | 605 423 |

### Pipette with two chambers

- For measuring out the exact dosage of drops or for thorough rinsing
- Front chamber = drops, rear chamber = rinsing
- Pipette end can be cut off for increased flow, e.g. for subgingival rinsing

| Article description | Content  | REF     |
|---------------------|----------|---------|
| Twin-Pipette        | 100 pcs. | 605 352 |

### Napkin holders

- Made of autoclavable rubber material with stainless steel clips

| Article description | REF     |
|---------------------|---------|
| Blue                | 605 240 |
| Yellow              | 605 241 |
| Violet              | 605 242 |
| White               | 605 243 |

### Elastic spiral napkin cord in two colours



| Article description | REF     |
|---------------------|---------|
| White               | 605 277 |
| Blue                | 605 278 |

### Container for disinfection

- Useful for small parts, such as burs, diamonds, etc.
- With opening in the lid
- With removable sieve for rinsing the content
- Both versions autoclavable
- Measures: Plastic: Total height approx. 12 cm, ø approx. 8 cm  
Metal: Total height approx. 5 cm, ø approx. 9 cm

| Article description   | REF     |
|-----------------------|---------|
| BD-Steribox (plastic) | 355 139 |
| BD-Steribox (metal)   | 355 138 |

## Twin-Pipette



## Miraclip®



## Napkin Holder Big



## BD-Steribox



## Variator®-Kit



### Disposable treatment set

- Comprises mouth mirror, tweezers and probe
- Big spatula for mixing of cement and filling materials
- Ball head and Heidemann spatula for stuffing
- Practical for home visits, high-risk patients and in emergencies
- All three instruments are gamma-sterilised and blister-packed as a unit

| Article description | Content | REF     |
|---------------------|---------|---------|
| Variator-Kit set    | 10 sets | 355 441 |

## Tweezer PL

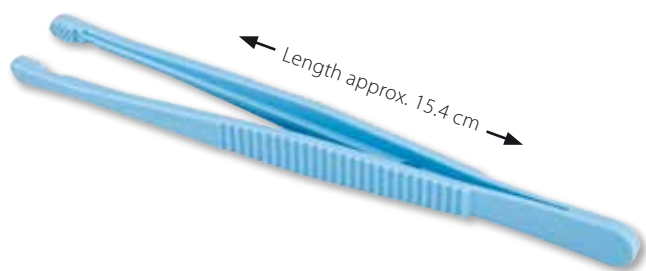

### Special toothed plastic tweezers

- Optimal grip due to toothed "gripping field" in every direction
- For gripping of very thin fibres, e.g. dental floss
- Autoclavable

| Article description | Content | REF     |
|---------------------|---------|---------|
| Tweezer PL          | 10 pcs. | 355 202 |

## Liftbox



### Disinfection box for dental instruments

- By closing the cover, the filled tray submerges into the disinfectant
- Tray with swivel handle for easy handling
- No direct skin contact with aggressive disinfectants
- Acid-resistant plastic

| Article description | Content | REF     |
|---------------------|---------|---------|
| Liftbox             | 1 pcs.  | 355 140 |

### High-quality inlay adapter

- Instrument with single rubber inserts
- Autoclavable

When re-ordering the rubber inserts, please state whether you require push-in inserts (old version) or covering inserts (new version)

| Article description                          | Content                       | REF     |
|--|-------------------------------|---------|
| Miralay set                                  | 2 instruments + 4 bite blocks | 355 210 |
| Miralay replacement rubber inserts (push in) | 2 pcs.                        | 355 211 |
| Miralay replacement rubber inserts (cover)   | 2 pcs.                        | 355 213 |

### Cotton roll holder

- Holds cotton rolls securely in place for a dry working field
- Available in light plastic or solid, autoclavable stainless steel

| Article description             | Content  | REF     |
|---------------------------------|----------|---------|
| Cotton-Clip I, plastic          | 100 pcs. | 605 350 |
| Cotton-Clip II, stainless steel | 8 pcs.   | 605 351 |

### Cotton roll dispenser

- Hygienic, dry storage
- Quick and easy to take out – simply open the drawer
- Drawer refills automatically
- Convenient top-loading function
- Stable, nonslip

| Article description   | Content | REF     |
|-----------------------|---------|---------|
| Cotton roll dispenser | 1 pcs.  | 355 132 |

### Special tweezers with dual function

#### For removal of scalpel blades

- Easy and safe removal of blade due to lever action
- We recommend the Miramatic-Box for the disposal of contaminated scalpels (see page 18)

#### Special tweezers with pin

- For holding crowns and bridges
- Both hands free due to pin
- Locking function

| Article description       | Content | REF     |
|---------------------------|---------|---------|
| Skalpell-Ex / Pin-Clipper | 1 pcs.  | 355 449 |

## Miralay®



## Cotton-Clip



## Cottoroll



## Skalpell-Ex / Pin-Clipper



## Spandex®



### Cheek and lip retractor

- Allows a free view and working field
- Ideal for treatment of anterior teeth and for taking photos
- Made of non-reflecting plastic
- Autoclavable



| Article description | Content | REF     |
|---------------------|---------|---------|
| Regular             | 2 pcs.  | 605 454 |
| Mini (children)     | 2 pcs.  | 605 455 |

## Spandex® -Vertical



### Lip retractor

- Expands patient's mouth in vertical direction
- For treatment at the gingival border of anterior teeth
- Autoclavable



| Article description                      | Content | REF     |
|--|---------|---------|
| Spandex-Vertical (2 x medium, 2 x small) | 4 pcs.  | 605 211 |
| Spandex-Vertical (medium)                | 6 pcs.  | 605 255 |

## Mirahold®



### One sided cheek retractor

- With long handle for a free working field
- Useful, e.g. for injections
- Convenient for the patient
- Autoclavable



| Article description | Content | REF     |
|---------------------|---------|---------|
| Mirahold regular    | 2 pcs.  | 605 450 |
| Mirahold bambino    | 2 pcs.  | 605 451 |

## Mirahold® -Block



### Elastic bite blocks for mouth opening

- Plastic block to keep the mouth open reliably
- The set includes a special cheek retractor
- Ideal for longer treatments and anxious patients
- Autoclavable

| Article description  | REF     |
|--|---------|
| Set with 12 bite blocks, 6 small and large each and 2 cheek retractors     | 605 210 |
| Intro set with 6 bite blocks, 3 small and large each and 1 cheek retractor | 605 238 |
| Mini set with 3 bite blocks (small)  | 605 220 |
| Cheek retractor separately   | 605 239 |



### Disposable anti-fog mouth mirror made of plastic

- With anti-fog coating
- Flat, angled mirror head for access to all areas in the oral cavity
- Ergonomic finger-grip handle
- Each mirror protected with foil and single packed
- For control of dental care at home

| Article description       | Content | REF     |
|---------------------------|---------|---------|
| White, ø 19 mm            | 50 pcs. | 605 416 |
| Transparent blue, ø 19 mm | 50 pcs. | 605 417 |
| Transparent pink, ø 19 mm | 50 pcs. | 605 418 |

### Disposable mouth mirror made of plastic

- Without anti-fog coating
- Available in two sizes, ø 19 mm and ø 23 mm
- Each mirror protected with foil and single packed, 100 pieces

| Article description   | Content  | REF     |
|-----------------------|----------|---------|
| No. 4, white, ø 19 mm | 100 pcs. | 605 400 |
| No. 5, white, ø 23 mm | 100 pcs. | 605 399 |

### Rhodium-coated metal mouth mirror

- Ideal for distortion-free intra-oral photos
- Extensive rhodium coating on one side
- Sturdy, durable
- With detachable silicone handle
- Autoclavable in the provided fabric bag

| Article description            | REF     |
|--------------------------------|---------|
| Set with 3 mirrors             | 355 480 |
| No. 1 separately (40 x 163 mm) | 355 481 |
| No. 2 separately (69 x 163 mm) | 355 482 |
| No. 3 separately (79 x 163 mm) | 355 483 |
| Silicone handle separately     | 355 487 |

### Mirror with parallel lines

- A proven specialty according to Prof. Böttger
- Fits all popular mirror handles (excluded from scope of delivery)
- Parallel check before imprint
- Autoclavable

| Article description   | REF     |
|-----------------------|---------|
| Parallelometer-Mirror | 355 470 |

## Brillant Anti-Fog



ø 19 mm



## Brillant

ø 23 mm



## Reflect-Rhod

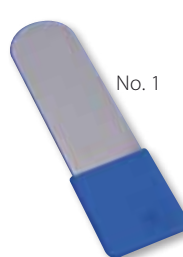

No. 1



No. 2



No. 3

## Parallelometer-Mirror



## Cold-Bag



### *Cold compress for pain relief*

- Instantly applicable, cools for approx. 30 minutes
- Develops effective iciness within seconds
- Reduces swellings
- Eco-friendly, may serve as fertilizer after use

| Article description | Content | REF     |
|---------------------|---------|---------|
| Cold-Bag compresses | 10 pcs. | 605 501 |

## Miracold® Plus



### *Cooling spray*

- Approx. -50 °C at the application canula (plastic)
- Orange flavour
- For vitality testing of devital teeth

| Article description | Content | REF     |
|---------------------|---------|---------|
| Miracold Plus       | 200 ml  | 554 213 |

## Orange Solvent®



### *Cleansing solution*

- For the removal of impression pastes, zinc oxide cements, dispersion adhesive (stickers, labels) from instruments
- Ideal for the cleaning of stainless steel
- Surfaces become shiny and are protected
- Fresh orange scent
- Available as liquid and spray

| Article description   | Content | REF     |
|-----------------------|---------|---------|
| Orange Solvent liquid | 250 ml  | 554 102 |
| Orange Solvent spray  | 200 ml  | 554 201 |

## Flexbrush



### *Autoclavable nail brush*

- Excellent for the cleaning of hands before and after treatment
- Extra long, hard-wearing bristles on the bottom
- Short bristles on the top

| Article description | REF     |
|---------------------|---------|
| Flexbrush           | 605 254 |

### Disinfection and cleaning wipes

- Disinfection of surfaces and inventory
- Bactericidal, fungicidal and virucidal (HIV/HBV/HCV)
- Fast, easy and secure
- Ideal for sensitive skin
- Free of alcohol, aldehyde, bleach and phenol
- Application time: 1 minute

| Article description | Content  | REF     |
|---------------------|----------|---------|
| Dispenser           | 115 pcs. | 554 302 |
| Refill pack         | 115 pcs. | 554 303 |

### Cleansing foam for dental practices

- Removes dirt, dirt rims, stains, etc. without effort
- For devices, plastic and wooden surfaces, etc.
- Supports bactericidal and disinfecting cleaning
- Tested by the neutral German "Institute for Hospital Hygiene and Infection Control" (IKI Gießen)

| Article description | Content | REF     |
|---------------------|---------|---------|
| Praxipolish Plus    | 400 ml  | 554 208 |

### Spray disinfection

- Particularly for disinfection of protective (uvex) glasses
- No damage to the anti-fog coating
- Generally usable for all surfaces in the medical field
- Bactericidal, fungicidal and virus-inactivating (HBV and HIV)

| Article description | Content | REF     |
|---------------------|---------|---------|
| Astro Clean         | 250 ml  | 554 301 |

### Disposable mask made of lightweight fleece material

- Hygienic and very good value for money



| Article description | Content  | REF     |
|---------------------|----------|---------|
| Miramask            | 100 pcs. | 605 412 |

## Mira® Cleaning Wipes



## Praxipolish® Plus



## Astro Clean®



## Miramask®



## uvex Super-Fit



### Safety glasses for best all-round visibility

- Large wrap-around lenses for maximal field of view
- Pressure-free and comfortable to wear
- Coating: outside extremely scratch-resistant, inside permanently mist-free



21 g

| Article description  | Lens  | REF     |
|----------------------|-------|---------|
| uvex Super-Fit white | clear | 304 428 |

## uvex Super-Fit UV



### UV protective eyewear

- Safe protection against UV radiation in extended wavelength range of 350 – 523 nm
- For all light polymerisation units
- Tested by NIOM (Nordic Institute of Dental Materials)
- Coating: outside extremely scratch-resistant, inside permanently mist-free



21 g

| Article description | Lens   | REF     |
|---------------------|--------|---------|
| uvex Super-Fit UV   | orange | 304 427 |

## H&W Classic



### The standard in protective eyewear

- Soft sides, adjustable with lock-in-place extension
- Provides full protection with 180° unobstructed view
- Anti-fog and anti-scratch lens
- 100% impact resistant polycarbonate lens



28 g

| Article description | Lens  | REF     |
|---------------------|-------|---------|
| H&W Classic         | clear | 355 622 |

### Eyewear technology at work

- Modern polishing techniques reduce distortions
- Fog reduction is the effect of a special ventilation system
- Light weight frame (25 g) prevents pressure on head and ears
- Silicone nose piece prevents sliding
- Silicone grips on temples
- Each pair includes a free neck strap



| Article description | Lense  | REF     |
|---------------------|--------|---------|
| Gold                | Clear  | 304 700 |
| Red                 | Clear  | 304 701 |
| Black               | Clear  | 304 702 |
| Hot Pink            | Clear  | 304 703 |
| Pink                | Clear  | 304 704 |
| Purple              | Clear  | 304 705 |
| Blue                | Clear  | 304 706 |
| Green               | Clear  | 304 707 |
| Black Sunglass      | Tinted | 304 709 |
| Silver              | Clear  | 304 710 |

## Hager Outback's



Hot Pink



Green

25 g



Gold

25 g



Purple



Silver

25 g



Pink



Red



Black



Black Sunglass  
with tinted lense



Blue

## uvex Pheos



30 g



## uvex i-3



30 g

## Proto-Cam



## CC-Shield



### Trendy protective glasses with wide field of view and perfect all-around vision

- Dual spherical protective glass offers ideal coverage of the eyes even in the area of the eye brows.
- Temple with integrated „climate-zone technology“ ensures you can work longer without fatigue
- High wearing comfort due to non-slip components
- 100 % UV protection
- Coating: Outside extremely scratch-resistant, inside permanent anti-fog coating

| Article description      | Lens  | REF     |
|--------------------------|-------|---------|
| Frame light grey/grey    | clear | 355 607 |
| Frame black/green        | clear | 355 608 |
| Frame black/orange       | grey  | 355 609 |
| Small: Frame white/green | clear | 355 610 |
| Small: anthrazit/grey    | clear | 355 611 |

### Innovative protective glasses

- Fits most head shapes
- Soft-flex nose and ear fitting
- Adjustable inclination

| Article description  | Lens  | REF     |
|----------------------|-------|---------|
| Frame white/lime     | clear | 355 612 |
| Frame anthrazit/blue | clear | 355 613 |

### Face shield

- Made of non-reflecting polycarbonate
- Lightweight frame for fixing to the head (25 g)
- Idea for works with prophylaxis blasting units

| Article description                               | REF     |
|---|---------|
| White frame with 5 replacement shields            | 355 535 |
| Transparent blue frame with 5 replacement shields | 355 546 |
| Pack with 5 replacement shields                   | 355 536 |

### Face Shield

- Highly impact-resistant and can be hinged upwards
- Fits any head size – adjustable Velcro fastening
- No light or colour reflex
- For working in the laboratory, etc.

| Article description | REF     |
|---------------------|---------|
| CC-Shield           | 355 508 |

### Laser protective glasses in modern design

- For laser 800 – 1064 nm\*
- Certified Safety Grade LB4
- Superior all-round visibility, optimal fit
- Plastic frame, weighing 27 g only

| Article description    | REF     |
|------------------------|---------|
| laservision Lambda One | 355 630 |

## laservision Lambda One



### Laser protective glasses for persons with glasses

- For laser 800 – 1064 nm\*
- Certified Safety Grade LB4
- Fits over all prescription glasses
- Superior all-round visibility, optimal fit
- Plastic frame, weighing 51 g

| Article description       | REF     |
|---------------------------|---------|
| laservision Skyline Green | 355 631 |

## laservision Skyline Green



### Laser protective glasses for persons with glasses

- For diode soft laser 657 – 660 nm\*
- Fits over all prescription glasses
- Superior all-round visibility, optimal fit
- Plastic frame, weighing 51 g

| Article description      | REF     |
|--------------------------|---------|
| laservision Skyline Blue | 355 632 |

## laservision Skyline Blue



\*All of our glasses are LaserHF compatible. Should you use another laser, please calculate the safety grades your laser requires and compare them with the information stated on the laser safety glasses, before using them.

### Laser protective glasses for patients

- Wideband protection\* by special metal insert
- Adjustable, elastic headband
- Also suitable for children
- Frame and metal insert sterilisable

| Article description                 | REF     |
|-------------------------------------|---------|
| laservision Patient's Laser Glasses | 355 633 |

## laservision Patient's Glasses



## Mirasuc®-View



### Aspiration canula with mirror developed by dentist Stephan Clasen, Münster, Germany

- Ideal aspiration and optimal view with one canula
- More light, better view, easier working
- Useful for all treatments with or without assistance
- Ergonomic operator posture easier to maintain
- ø 16 mm, length 12 cm, mirror size 4
- Mirror and canula autoclavable separately



| Article description | Content | REF     |
|---------------------|---------|---------|
| Mirasuc-View        | 10 pcs. | 254 035 |
| Replacement mirror  | 10 pcs. | 254 036 |

## Mirasuc® 16



### Autoclavable plastic aspiration canula

- Large square aspirator head, slightly rounded
- Ideal for aspiration with free view to working field at the same time
- ø 16 mm, length 12 cm
- Autoclavable

#### Set with 10 pieces

| Article description                | Content | REF     |
|------------------------------------|---------|---------|
| Blue                               | 10 pcs. | 254 018 |
| Grey                               | 10 pcs. | 254 019 |
| Assorted (5 x blue and green each) | 10 pcs. | 254 010 |

## Mirasuc® Adapter



### Extensions and connecting pieces for aspiration canulas

- Made of plastic, for all conventional suction units
- Extension from 6 mm to 16 mm (e) possible by combination of adapters (a) and (d)

| Article description  | REF     |
|--|---------|
| a) White, from 11 mm to 16 mm  | 254 130 |
| b) Orange, from 11 mm to 16 mm   | 254 131 |
| c) Grey, autoclavable, finger-grip handle extends the canula from 11 mm to 16 mm | 254 133 |
| d) White, from 6 mm (salvia ejector) to 11 mm                                    | 254 132 |
| e) Combination of adapters a) and d), from 6 to 16 mm                            | 254 105 |
| f) Grey, adapter reduction from 16 mm to 11 mm                                   | 254 105 |



### Autoclavable plastic aspiration canula

- Very convenient for the patient, with round head
- Also ideal in paediatric dentistry
- ø 11 mm, length 10.5 cm
- Autoclavable

**Set with 10 pieces including 1 adapter (from ø 11 mm to 16 mm)**

| Article description                          | Content | REF     |
|--|---------|---------|
| Green  | 10 pcs. | 254 024 |
| Blue   | 10 pcs. | 254 025 |
| Grey   | 10 pcs. | 254 026 |
| Assorted (4 x grey, 3 x blue and green each) | 10 pcs. | 254 029 |

### Disposable plastic aspiration canula

- Canula with round head
- ø 11 mm, length 10 cm

**Box with 50 pieces including 1 adapter (from ø 11 mm to 16 mm)**

| Article description | Content | REF     |
|---------------------|---------|---------|
| White               | 50 pcs. | 254 022 |
| Orange              | 50 pcs. | 254 023 |

### Longer disposable plastic aspiration canula

- With square head
- ø 11 mm, length 14 cm

**Box with 50 pieces**

| Article description | Content | REF     |
|---------------------|---------|---------|
| White               | 50 pcs. | 254 020 |
| Orange              | 50 pcs. | 254 021 |

## Pelotte Plus



## Pelotte-Aspirator



## Mirasucto®



## Chiru-Tip



### Surgical aspiration canula

- Ergonomic finger-grip handle, "non-stick indentation"
- Canula diameter 2 mm
- Fits to saliva ejector and hoses with a diameter of 11 mm and 16 mm
- 10 tips and handles each
- Autoclavable

| Article description | Content | REF     |
|---------------------|---------|---------|
| Chiru-Tip white     | 10 pcs. | 254 007 |

## Chirurgo-Suc® I



### Sterile disposable surgical aspiration canula

- Extremely long (20 cm) for a free working field
- Fits all hoses with adapter
- Transparent plastic
- Individually sterile sealed
- Canula diameter: 2 mm

Set with 10 pieces incl. 1 adapter-set

| Article description | Content | REF     |
|---------------------|---------|---------|
| Chirurgo-Suc I      | 10 pcs. | 254 000 |

## Steri-Suc®-Tube



### Surgical aspiration canula

- Made of high-quality, transparent, honey-coloured plastic
- Safe when getting into contact with activated electrodes (e.g. p. 55) or rotating instruments
- Autoclavable
- Fits to saliva ejector (6 mm) without adapter
- Ultra-light with approx. 3 g weight
- Incl. one Chiru-Cleaner (No. 23, REF 605 215)

| Article description | Content | REF     |
|---------------------|---------|---------|
| Steri-Suc-Tube      | 10 pcs. | 254 060 |

## Mirasuc® Brush



### Cleaning brush for aspiration canulas

- Bendable, ideal for cleaning inside of canulas
- For all aspiration canulas with ø 11 mm and 16 mm

| Article description | Content | REF     |
|---------------------|---------|---------|
| Mirasuc Brush       | 6 pcs.  | 605 216 |

## Chiru-Cleaner®

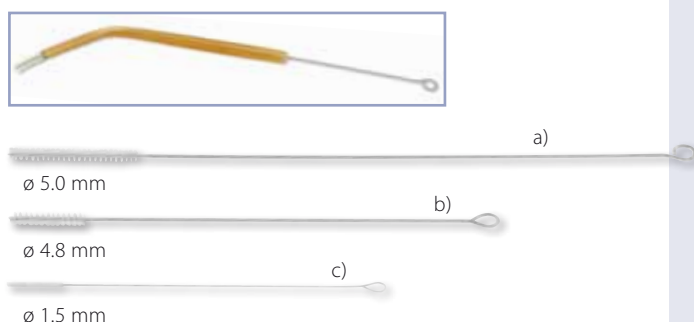

### Cleaning brushes for surgical canulas

| Article description                        | Content | REF     |
|--|---------|---------|
| a) Chiru-Cleaner 23, 23 cm long            | 12 pcs. | 605 215 |
| b) Chiru-Cleaner 16, 16 cm long            | 6 pcs.  | 605 217 |
| c) Chiru-Cleaner 12, cotton tip 12 cm long | 5 pcs.  | 605 213 |

### Basic equipment I for rubber dam technique

- 1 board with 12 clamps complete
- 1 Fit clamp forceps
- 1 Fit punch
- 1 Fit steel frame large
- 1 Fit Rubberdam brochure

| Article description         | REF     |
|-----------------------------|---------|
| Fit-Rubberdam Starter Kit I | 355 320 |

### Basic equipment II for rubber dam technique

- 1 board with 12 clamps complete
- 1 Fit clamp forceps
- 1 Fit punch
- 1 Fit latex medium (36 sheets)
- 1 Fit folding frame (plastic)
- 1 Perforated template
- 1 Fit Rubberdam brochure

| Article description          | REF     |
|------------------------------|---------|
| Fit-Rubberdam Starter Kit II | 355 338 |

### For making the holes in rubber dam prior to perforation

- Solid plastic

| Article description                | REF     |
|------------------------------------|---------|
| Fit Rubberdam Template, 15 x 15 cm | 355 318 |

### Clamp board available with and without clamps

#### Stainless steel board, with 8 clamps

2 x No. 9, 1 x each: Nos. 2A, W2A, 5, 56, 203, 2044

#### Stainless steel board with 12 clamps

1 x each: Nos. 5, 7, 56, 201, 202, 206, 207, 210, 211, 0, 2, 2A

#### Stainless steel board with 18 clamps

j1 x each: Nos. P1, P2, 18, 22, 27, 29, 200, 201, 202, 203, 204, 205, 208, 209, 138, 139, 210, 211

| Article description                         | REF     |
|---|---------|
| Clamp Board with 8 clamps                   | 355 330 |
| Clamp Board with 12 clamps                  | 355 331 |
| Clamp Board with 18 clamps                  | 355 332 |
| Clamp Boardf without clamps (for 8 clamps)  | 355 327 |
| Clamp Boardf without clamps (for 12 clamps) | 355 328 |
| Clamp Boardf without clamps (for 18 clamps) | 355 329 |

### Fit® Punch – for perfectly punched, tearproof perforations

- Movable punching pin constantly using the whole cutting border
- Made of stainless steel

### Fit® Clamp Forceps – for smooth grasp of the clamps

- Arbitrarily fixable
- No tilting of clamp

| Article description | REF     |
|---------------------|---------|
| Fit Punch           | 355 321 |
| Fit Clamp Forceps   | 355 333 |

## Fit® Rubberdam Starter Kit I



## Fit Rubberdam® Starter Kit II

## Fit® Rubberdam Perforating Template



## Fit® Rubberdam Clamp Board



## Fit® Rubberdam Forceps



# Fit® Rubberdam Clamps

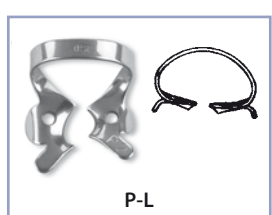
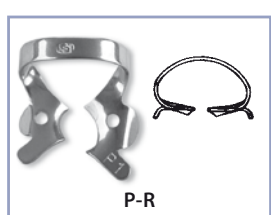
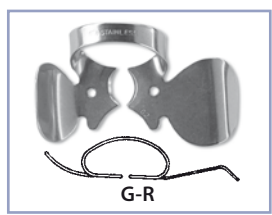
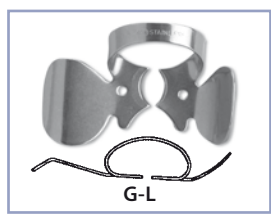
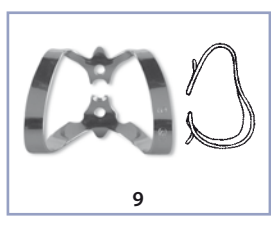
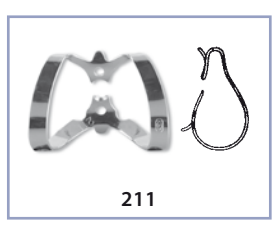
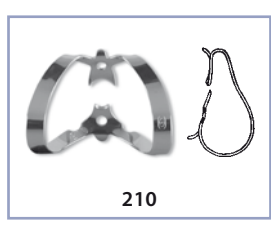

## Cervical Clamp 214



Our Fit Rubberdam clamps are made of stainless steel and every single one is adjusted exactly, precisely and effectively for the tooth it is intended for. 0.66 mm thick stainless steel is used for the high quality.

### Ivory style (labial)

| Article description | REF     |
|---------------------|---------|
| 210                 | 355 384 |
| 211                 | 355 385 |
| 9                   | 355 355 |

Free booklet available!



### Ivory style (cervical)

| Article description | REF     |
|---------------------|---------|
| 212                 | 355 386 |

### With cotton roll holder

| Article description         | REF     |
|-----------------------------|---------|
| Set with clamps G-L and G-R | 355 389 |

### For children R + L

- For the first permanent molars

| Article description | REF     |
|---------------------|---------|
| P-R                 | 355 387 |
| P-L                 | 355 388 |

### Special clamp

- For exposure of the tooth neck and for temporary retraction of the gingiva
- Screw fixation guarantees a firm grip
- Ideal e.g. for adhesive fixing of veneers

| Article description | REF     |
|---------------------|---------|
| Cervical Clamp 214  | 355 400 |

### Specified rubber dam clamps

- For the labial, premolar and molar area
- With special retentions for a better fixing at the tooth

#### Labial T-clamp

| Article description | REF     |
|---------------------|---------|
| 9T                  | 355 754 |



#### Premolar T-clamps

| Article description | REF     |
|---------------------|---------|
| 1T                  | 355 752 |
| 1AT                 | 355 753 |
| 2T                  | 355 750 |
| 2AT                 | 355 751 |



#### Molar T-clamps

| Article description | REF     |
|---------------------|---------|
| 14T                 | 355 758 |
| 56T                 | 355 759 |



#### Special Rubberdam clamps for children

- Especially designed for the anatomic shape of deciduous teeth
- Ideal for pediatric dentistry

| Article description                    | Quadrant    | REF     |
|--|-------------|---------|
| 55E                                    | upper right | 355 723 |
| 54D                                    | upper right | 355 722 |
| 64D                                    | upper left  | 355 724 |
| 65E                                    | upper left  | 355 725 |
| 85E                                    | lower right | 355 729 |
| 84D                                    | lower right | 355 728 |
| 74D                                    | lower left  | 355 726 |
| 75E                                    | lower left  | 355 727 |
| Kit with 8 clamps on a clamp board     |             | 355 720 |
| Clamp board separately, without clamps |             | 355 721 |

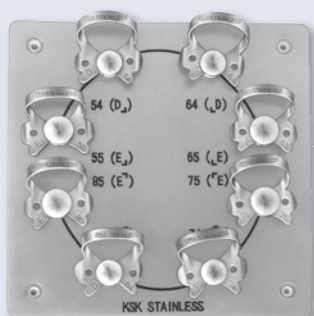

### Fit® Rubberdam Clamps for Children



# Fit Rubberdam Clamps

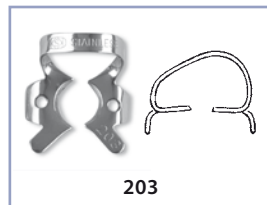
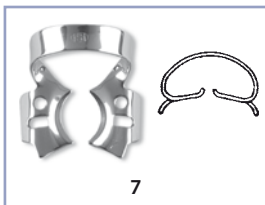
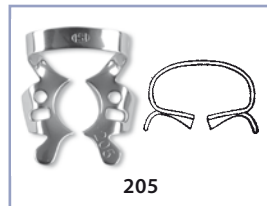
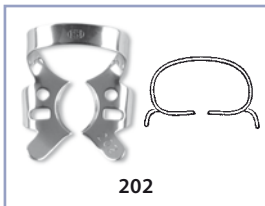
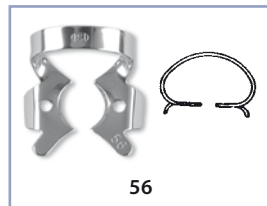
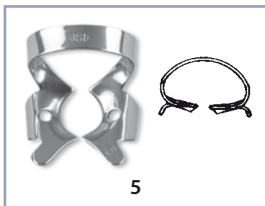
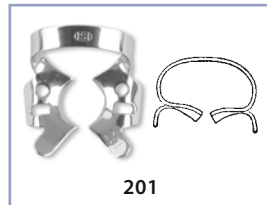
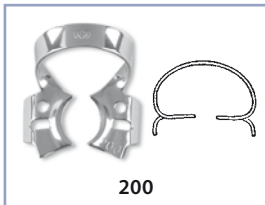
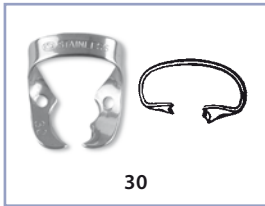
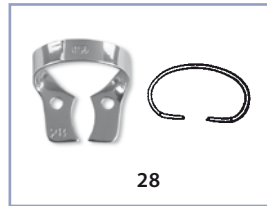
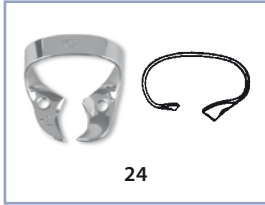
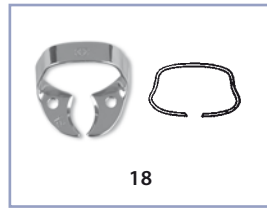

## Molar clamps wingless

| Article description | REF     |
|---------------------|---------|
| 15                  | 355 358 |
| 18                  | 355 359 |
| 24                  | 355 361 |
| 25                  | 355 362 |
| 26                  | 355 363 |
| 28                  | 355 365 |
| 30                  | 355 367 |
| 31                  | 355 368 |
| 51                  | 355 369 |
| 138                 | 355 372 |
| 139                 | 355 373 |
| W8A                 | 355 354 |

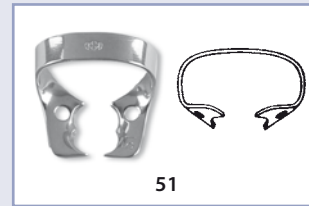

## Molar clamps with wings

| Article description | REF     |
|---------------------|---------|
| 200                 | 355 374 |
| 201                 | 355 375 |
| 5                   | 355 349 |
| 56                  | 355 370 |
| 202                 | 355 376 |
| 205                 | 355 379 |
| 7                   | 355 350 |
| 203                 | 355 377 |
| 204                 | 355 378 |
| 7A                  | 355 351 |

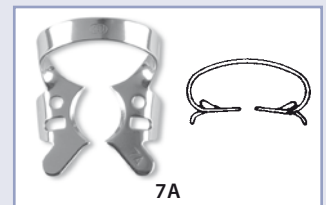
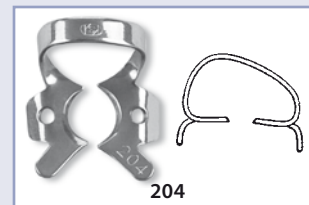

### Molar clamps with wings (for deep gripping)

| Article description | REF     |
|---------------------|---------|
| 3                   | 355 346 |
| 4                   | 355 348 |
| 8                   | 355 352 |
| 8A                  | 355 353 |
| 14                  | 355 356 |
| 14A                 | 355 357 |

Should the friction of the clamp be insufficient, an activation, e. g. with pointed forceps, is possible.

### Premolar clamps wingless

| Article description | REF     |
|---------------------|---------|
| W2A                 | 355 345 |
| 22                  | 355 360 |
| 27                  | 355 364 |
| 29                  | 355 366 |

Continuous user will appreciate our fine spring-stainless-steel

### Premolar clamps with wings

| Article description | REF     |
|---------------------|---------|
| 00                  | 355 341 |
| 0                   | 355 340 |
| 206                 | 355 380 |
| 207                 | 355 381 |
| 209                 | 355 383 |
| 208                 | 355 382 |
| 2                   | 355 343 |
| 2A                  | 355 344 |

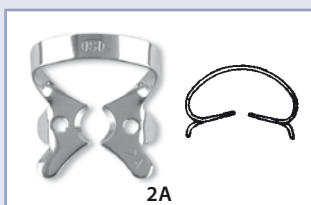
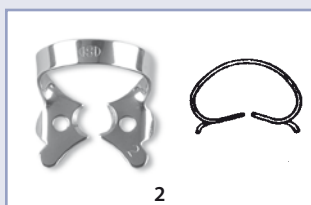

## Fit® Rubberdam Clamps

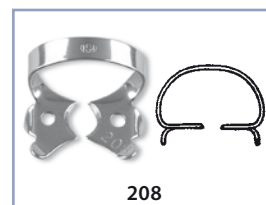
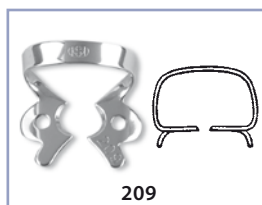
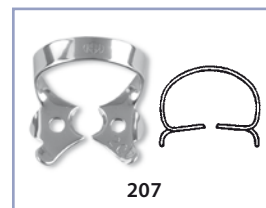
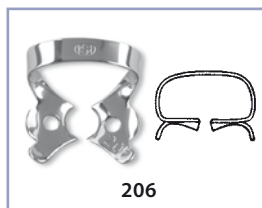
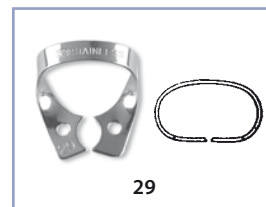
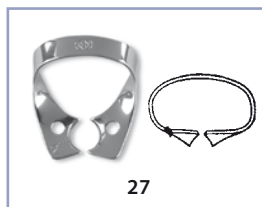
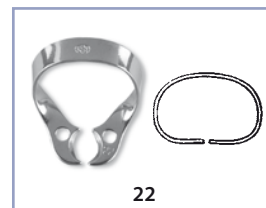
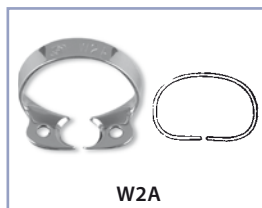

## Fit® Rubberdam-Latex



### Made of natural latex rubber

- Medium: extra smooth-running due to approximal contact
- Heavy: for a stronger retention of the gingival
- High tensile strength due to constant quality
- Durability one year minimum, if stored in a cool place
- Green sheets (15 x 15 cm), powdered on one side

| Article description | Thickness    | Content  | REF     |
|---------------------|--------------|----------|---------|
| Fit Latex Medium    | 0.18–0.23 mm | 36 sheet | 355 335 |
| Fit Latex Heavy     | 0.23–0.29 mm | 36 sheet | 355 336 |

For an easier and quicker insertion of the Fit Rubberdam-Latex in case of close contact points we recommend using our Miradont-Gel (page 51) as lubricant.

## Fit® Rubberdam Eliot Separator



### Specifically for widening of interdental spaces for a short time

| Article description | REF     |
|---------------------|---------|
| Eliot Separator     | 355 325 |

## Fit® Rubberdam Steel Frame

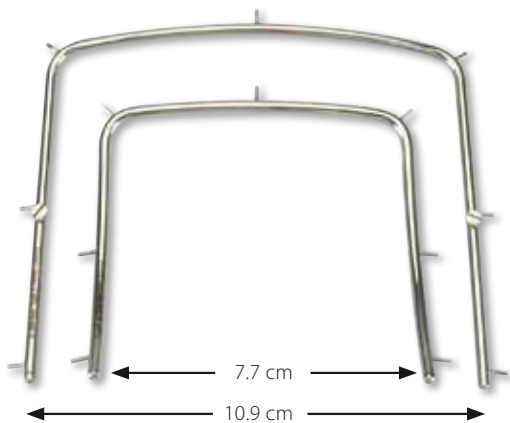

### Solid stainless steel frame

- For tightening of rubber dam without perforation
- Autoclavable

| Article description | REF     |
|---------------------|---------|
| Frame I = large     | 355 324 |
| Frame II = small    | 355 323 |

## Fit® Folding Frame



### Foldable plastic frame

- Foldable in the center, easy access
- Avoid reflections when taking X-rays, ideal for endodontics
- Autoclavable

| Article description | REF     |
|---------------------|---------|
| Folding frame       | 355 319 |



## Tooth-coloured repair and universal material

- Cost-effective alternative
- Direct adhesion – without primer, bonding or underlining
- Very fast and easy to handle
- Viscosity variable depending on application
- Good, colour-fast results with low effort

### Basic equipment

25 g colour powder A2, 15ml bottle Quick accelerator, 3 x 5 g ampoules Fast, 5 g ampoule Retarder, 1 mixing pad with 30 wooden mixing spatulas, 2 replacement tips with rubber cap, 50 brushes and 1 brush holder, 30 pipettes for fine doses as well as instructions for use and compendium

### Bracket kit

5 g Fast, 5 g Retarder, 15 ml Quick with canula, 12.5 g colour powder Incisal, 1 mixing pad, 1 brush holder, 50 mixing brushes, 30 mixing spatulas, instructions for use

| Article description | REF     |
|---------------------|---------|
| Basic equipment     | 152 251 |
| Bracket kit         | 152 252 |

## Cyano-Veneer® accessories

| Article description    | Content               | REF     |
|------------------------|-----------------------|---------|
| Wooden spatula         | ca. 400 pcs.          | 152 269 |
| Mixing block           | 2 pcs. 50 sheets each | 152 270 |
| Pipette for fine doses | 100 pcs.              | 152 268 |
| Brush holder           | 2 pcs.                | 152 267 |
| Disposable brush       | 50 pcs.               | 152 266 |

## Cyano-Veneer® powder in Vita colours

| Article description | Content    | REF     |
|---------------------|------------|---------|
| A2                  | 2 x 12.5 g | 152 254 |
| A3.5                | 2 x 12.5 g | 152 255 |
| B3                  | 2 x 12.5 g | 152 256 |
| C3                  | 1 x 12.5 g | 152 257 |
| Incisal             | 1 x 12.5 g | 152 259 |

## For mixing Cyano-Veneer® liquids

- Fast: normally curing bonding, adhesion and mixing fluid
- Retarder: slowly curing bonding, adhesion and mixing fluid

| Article description   | Content             | REF     |
|-----------------------|---------------------|---------|
| Cyano-Veneer Fast     | 4 bottles, 5 g each | 152 261 |
| Cyano-Veneer Retarder | 4 bottles, 5 g each | 152 262 |

## Removes all cyano-acrylates

| Article description | Content | REF     |
|---------------------|---------|---------|
| Cyano Ex            | 20 ml   | 152 272 |

# Cyano-Veneer®

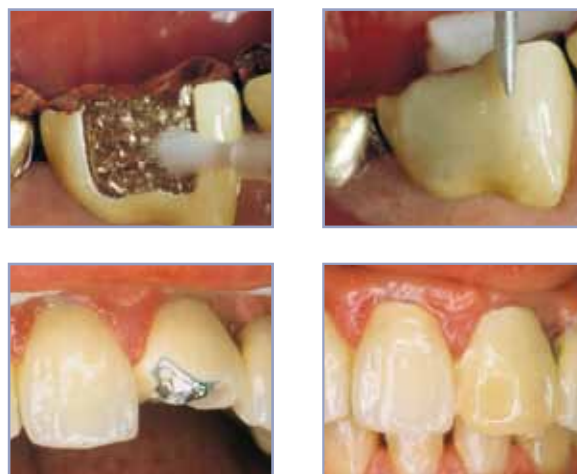

## Cyano-Veneer® Accessories



## Mixing Liquids



## Cyano Ex



## Perfect Splint C®



### Pre-manufactured splinting nets in four sizes

- For splinting, stabilisation and interim provision
- Time-saving: easy-to-adapt and fix by bow shape
- The size of the dental bow to be treated can be determined fast and safely by the curved archetypes (dummies), 98 % fitting-accuracy



User Report

| Article description                     | Content     | REF     |
|---|-------------|---------|
| Combi set stainless steel/plastic (PET) | 8 pcs. each | 153 000 |
| Set stainless steel                     | 8 pcs.      | 153 001 |
| Set plastic (PET)                       | 8 pcs.      | 153 002 |

Refill packs with 10 bows and dummies available on request.

## Perfect Splint-System

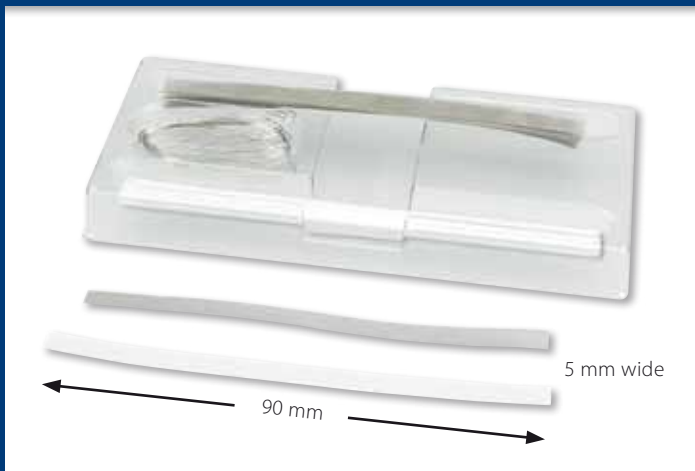

### Straight splinting nets

- Cutable plastic (PET) or stainless steel nets for splinting
- Each pack sufficient for the splinting of approx. 200 teeth

#### Complete pack

| Article description   | REF     |
|---|---------|
| 10 stainless steel and plastic (PET) nets each, attachment aid (orthodontic wire) | 152 280 |

#### Single packs

| Article description  | REF     |
|--|---------|
| 20 stainless steel nets, attachment aid (orthodontic wire) | 152 281 |
| 20 PET nets, attachment aid (orthodontic wire)             | 152 282 |

## Super-Splint De Luxe



### Multilayer splinter material

- 6 sewed on layers of fine meshed, ultra-thin and silanised glass fibre tape
- 4 mm wide, for approx. 25 applications

| Article description              | REF     |
|----------------------------------|---------|
| Super-Splint De Luxe, 50 cm tape | 355 848 |

### Glass fibre tape for splinting and strengthening

- Extremely flexible, easy-to-adapt, very easy to handle and apply
- Several layers of the tape may be arranged on top of each other with composite
- 4 mm wide, silanised tape, for up to 50 applications

| Article description    | REF     |
|------------------------|---------|
| Super-Splint, 3 m tape | 355 849 |

## Super-Splint

### Fissure stamp for composite fillings

- Easy, good and fast occlusal modulation of lateral composite fillings
- No more manual modulation of the occlusal surfaces
- Translucent plastic, may be disinfected
- Polymerisation by placing the lamp onto the stamp
- Molar and premolar disposable stamp in 16 different sizes and shapes, separated into upper/lower jaw and right/left jaw
- The tooth number is stated on the stamp top for an easy identification

| Article description                    | REF     |
|--|---------|
| Intro kit with 32 stamps (16 x 2 pcs.) | 605 494 |
| Set with 160 stamps (16 x 10 pcs.)     | 605 477 |

Refills with 10 pcs. each available separately in 16 sizes

### 37% phosphoric acid

- Viscous gel
- Dyed red for better visualisation on the enamel
- Easily measured from the syringe
- For approx. 30 applications

Further application needles: Miraject Endo Luer (see page 16)

| Article description        | REF     |
|----------------------------|---------|
| 2ml syringe with 2 canulas | 152 284 |

### Ready for use calcium hydroxide paste (45 %)

- For direct capping after opening of the pulp or in case of pulpotomy, indirect capping in case of caries profunda
- For temporary root canal fillings and root canal disinfections
- High pH-value (over 11.5) for antimicrobial effect, radiopaque
- Economic and easy-to-measure
- Appropriate underneath all underfilling and filling materials
- Incl. curing-aid cap

Further application needles: Miraject Endo Luer (see page 16)

| Article description        | REF     |
|----------------------------|---------|
| 2ml syringe with 2 canulas | 152 283 |

### Matrix retainer "Tofflemire" style

- High-quality stainless steel
- Autoclavable

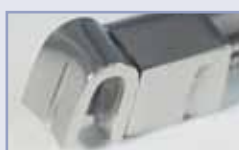

| Article description      | REF     |
|--------------------------|---------|
| Standard universal No. 1 | 355 043 |
| Angled No. 2             | 355 047 |
| Junior (short) No. 3     | 355 048 |

## Occlu-Print®



## Micro-Etch



## Calci-Line®



## Matrix- Retainers



# Crown Click® De Luxe



## Mechanical crown and bridge remover

- Very effective due to impulse wave
- Just place the instrument tip underneath the crown rim and release the "click"
- Instrument tip in three designs with additional loop (optional)
- Fast, efficient and easy crown and bridge removal
- High-quality, mattfinished stainless steel, autoclavable



| Article description                 | REF     |
|-------------------------------------|---------|
| Set: instrument with tips (No. 1–3) | 452 205 |
| Tip No. 1 (long)                    | 452 206 |
| Tip No. 2 (short)                   | 452 207 |
| Tip No. 3 (short + angle)           | 452 208 |
| Loop tip No. 4 (incl. adapter)      | 452 209 |
| Loop tip replacement wire, 2 pcs.   | 452 210 |

# Gripit®



## Bite cushion with high adhesion force

- For removal of temporary work
- Heat bite cushion, put in place and remove temporary work by instructing the patient to open his mouth jerkily
- Safe and very convenient for the patient
- Two pieces hygienically packed

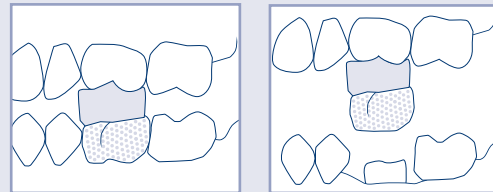

| Article description | Content          | REF     |
|---------------------|------------------|---------|
| Gripit              | 50 (25 x 2) pcs. | 605 283 |

# C-EX® / B-EX®



## Gripping clamp for removal of crowns and bridges

- High-quality chromium-nickel alloy
- No tilting possible
- B-EX with pointed tip for bridges
- C-EX with broad tip for crowns
- Autoclavable



| Article description | REF     |
|---------------------|---------|
| Bridge remover      | 355 203 |
| Crown remover       | 355 204 |

### High-quality green occlusion spray

- For marking of contact points by direct spraying onto the occlusal surfaces
- Micro powder layer for highest accuracy
- Plastic nozzle for extra fine spray mist
- Powder layer can be easily removed with water
- Economic in consumption

| Article description | Content | REF     |
|---------------------|---------|---------|
| Aerosol can green   | 75 ml   | 554 205 |
| Aerosol can green   | 50 ml   | 554 211 |
| Aerosol can red     | 50 ml   | 554 215 |

### Marking instrument

- With green marking tip
- For markings on the oral mucosa (A-line, pressure marks, fracture lines, crown margins, etc.) before taking an impression

| Article description                  | REF     |
|--------------------------------------|---------|
| Instrument with 5 green marking tips | 355 315 |
| 5 green marking tips separately      | 355 316 |

### For checking interdental contact points

- Holder made of stainless steel
- Strong stainless steel contact tapes
- In three colour-coded thicknesses

| Article description                 |           | REF     |
|-------------------------------------|-----------|---------|
| Set with holder and 1 tape each     |           | 355 306 |
| Replacement band separately, blue   | ø 0.05 mm | 355 307 |
| Replacement band separately, red    | ø 0.11 mm | 355 308 |
| Replacement band separately, yellow | ø 0.15 mm | 355 309 |

### Amalgam depot made of stainless steel

- Funnel-shaped for easy pick-up
- Allows pick-up of amalgam without skin contact
- Stable and non-slip
- Autoclavable

| Article description | REF     |
|---------------------|---------|
| Amalgam Well        | 355 000 |

### Plastic caps for core build-up

- Time-saving as modelling of the cured core is simplified
- Cost-saving as significantly less composite is needed
- Minimised risk of accidental damage to neighbouring teeth
- Standard shape of caps suits any core build-up
- Transparent and light conducting caps in six sizes
- Thin-walled caps can simply be adapted with scissors
- May basically be used with any commercial root canal post system and core build-up composite

Refill kits with 10 caps per size on request

| Article description                    | REF     |
|--|---------|
| Kit of 72 with 12 caps each in 6 sizes | 605 470 |

## Occlu® Spray Plus



## Exact Liner



## Contact Gauge



## Amalgam Well



## Mirafit® BC

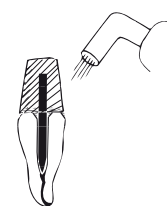
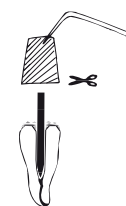

## Mirafit® 3 in 1



### Build-up post from white glass fibre

- Biocompatible material, physical properties similar to dentine
- Thread-free, gentle to the tooth substance, radiopaque
- Cone-shaped, size may be adjusted individually with the aid of three colour marks on the post:

Yellow mark: Post length 2.9 mm, approx. ISO size 60

Red mark: Post length 8.25 mm, approx. ISO size 80

Blue mark: Post length 17.5 mm, approx. ISO size 110 (overall post length 35 mm)

| Article description                                   | REF     |
|---|---------|
| Kit: 6 posts, 1 depth reamer and 3 root canal reamers | 356 074 |

### Refill packs

| Article description             | Content | REF     |
|---------------------------------|---------|---------|
| Posts                           | 6 pcs.  | 356 080 |
| Depth reamer                    | 3 pcs.  | 356 081 |
| Root canal reamer yellow, small | 3 pcs.  | 356 082 |
| Root canal reamer red, medium   | 3 pcs.  | 356 083 |
| Root canal reamer blue, large   | 3 pcs.  | 356 084 |

## Mirafit® Carbon und White

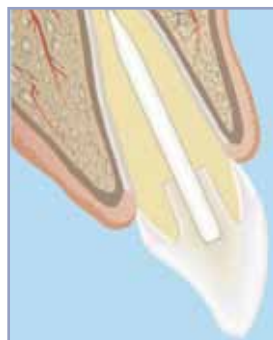
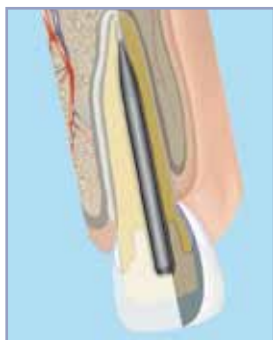

### Thread-free reconstruction post made of carbon and glass fibre

- Physical properties of the post similar to those of dentine and reconstruction composite
- No risk of corrosion due to biocompatible metal-free material
- Preparation very gentle to the tooth substance
- Extra-long and easy to shorten post, can easily be removed by means of a bur
- Available in 3 conventional diameters:  
L2 = Ø 1.20 mm    L3 = Ø 1.35 mm    L4 = Ø 1.50 mm

#### Mirafit Carbon

- Post visible on X-rays due to radiopaque cement

#### Mirafit White

- The white colour of the post meets high esthetical requirements
- Radiopaque

| Article description     | Content                       | REF     |
|-------------------------|-------------------------------|---------|
| Mirafit Carbon kit      | 3 x 6 posts and 1 reamer each | 356 040 |
| Mirafit Carbon, post L2 | Ø 1.20 mm, 6 pcs.             | 356 041 |
| Mirafit Carbon, post L3 | Ø 1.35 mm, 6 pcs.             | 356 042 |
| Mirafit Carbon, post L4 | Ø 1.50 mm, 6 pcs.             | 356 043 |
| Mirafit White kit       | 3 x 6 posts and 1 reamer each | 356 044 |
| Mirafit White, post L2  | Ø 1.20 mm, 6 pcs.             | 356 045 |
| Mirafit White, post L3  | Ø 1.35 mm, 6 pcs.             | 356 046 |
| Mirafit White, post L4  | Ø 1.50 mm, 6 pcs.             | 356 047 |
| Mirafit reamer L2       | 3 pcs.                        | 356 048 |
| Mirafit reamer L3       | 3 pcs.                        | 356 049 |
| Mirafit reamer L4       | 3 pcs.                        | 356 050 |

### Fibre post system

- Highly radiopaque (35% AL) and light transmitting for the use of dual curing resin cements
- Conical shape with mechanical retention slots - with colour coding
- Aesthetic thanks to its translucent matrix
- 100% biocompatible- epoxy free

| Article description                | Content | REF     |
|------------------------------------|---------|---------|
| Intro kit, 4 x 5 posts + 4 reamers |         | 357 000 |
| Refill No. 1                       | 10 pcs. | 357 001 |
| Refill No. 2                       | 10 pcs. | 357 002 |
| Refill No. 3                       | 10 pcs. | 357 003 |
| Refill No. 4                       | 10 pcs. | 357 004 |
| Reamer No. 1                       | 3 pcs.  | 357 005 |
| Reamer No. 2                       | 3 pcs.  | 357 006 |
| Reamer No. 3                       | 3 pcs.  | 357 007 |
| Reamer No. 4                       | 3 pcs.  | 357 008 |

## Mirafit® Clear



Intro kit

### Inexpensive build-up post

- Self-cutting thread
- In two versions: titanium or 24 carat gold-plated
- Gets directly screwed in or cemented
- In four lengths: short (8 mm), medium (9.5 mm), long (12 mm), x-long (14 mm)
- In six diameters: No. 1 (1.05 mm), No. 2 (1.20 mm), No. 3 (1.35 mm), No. 4 (1.50 mm), No. 5 (1.65 mm), No. 6 (1.80 mm)
- Sets include three, six or twelve posts per size



Gold-plated set with hollow and cross-type driver, titanium set with hollow driver

| Article description  | Content      | REF     |
|----------------------|--------------|---------|
| Set 240, gold-plated | 20 x 12 pcs. | 355 975 |
| Set 120, titanium    | 20 x 6 pcs.  | 355 998 |
| Set 60, gold-plated  | 20 x 3 pcs.  | 355 974 |
| Set 60, titanium     | 20 x 3 pcs.  | 355 973 |

#### Reamer

| Article description           | ø    | Content | REF     |
|-------------------------------|------|---------|---------|
| Set 1-6                       |      |         | 355 997 |
| No. 1                         | 1.05 | 3 pcs.  | 356 020 |
| No. 2                         | 1.20 | 3 pcs.  | 356 021 |
| No. 3                         | 1.35 | 3 pcs.  | 356 022 |
| No. 4                         | 1.50 | 3 pcs.  | 356 023 |
| No. 5                         | 1.65 | 3 pcs.  | 356 024 |
| No. 6                         | 1.80 | 3 pcs.  | 356 025 |
| Hollow driver, separately     |      |         | 356 027 |
| Cross-type driver, separately |      |         | 356 028 |

## Mira-Post®

Gold-plated



Titanium



Refill pack with 6 reamers titanium:  
Refill pack with 6 reamers gold-plated:

|                                | S<br>(8 mm)             | M<br>(9.5 mm)           | L<br>(12 mm)            | XL<br>(14 mm)           |
|--------------------------------|-------------------------|-------------------------|-------------------------|-------------------------|
| <b>Reamer NF (pack with 3)</b> |                         |                         |                         |                         |
| <b>No. 6 (ø 1.80)</b> 356 025  | G 355 981<br>Ti 356 004 | G 355 987<br>Ti 356 010 | G 355 993<br>Ti 356 016 | G 355 995<br>Ti 356 018 |
| <b>No. 5 (ø 1.65)</b> 356 024  | G 355 980<br>Ti 356 003 | G 355 986<br>Ti 356 009 | G 355 992<br>Ti 356 015 |                         |
| <b>No. 4 (ø 1.50)</b> 356 023  | G 355 979<br>Ti 356 002 | G 355 985<br>Ti 356 008 | G 355 991<br>Ti 356 014 | G 355 994<br>Ti 356 017 |
| <b>No. 3 (ø 1.35)</b> 356 022  | G 355 978<br>Ti 356 001 | G 355 984<br>Ti 356 007 | G 355 990<br>Ti 356 013 |                         |
| <b>No. 2 (ø 1.20)</b> 356 021  | G 355 977<br>Ti 356 000 | G 355 983<br>Ti 356 006 | G 355 989<br>Ti 356 012 |                         |
| <b>No. 1 (ø 1.05)</b> 356 020  | G 355 976<br>Ti 355 999 | G 355 982<br>Ti 356 005 | G 355 988<br>Ti 356 011 |                         |

## Airsonic® Mini Sandblaster



### Handy sandblaster

- For roughening of bonding surfaces of crowns, bridges, brackets, posts, etc.
- Thoroughly roughened bonding surfaces for optimal bonding of various materials
- Ideal for all metals and ceramics
- Also suitable for the removal of cement residues from crowns and bridges

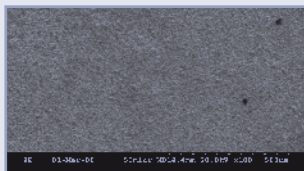

Before sandblasting

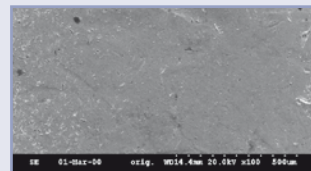

After sandblasting

| Article description                                      | REF     |
|--|---------|
| Sandblaster, standard nozzle 60° and 20 g powder (50 µm) | 401 080 |
| Nozzle 60° separately                                    | 401 086 |

## Airsonic® Adapters

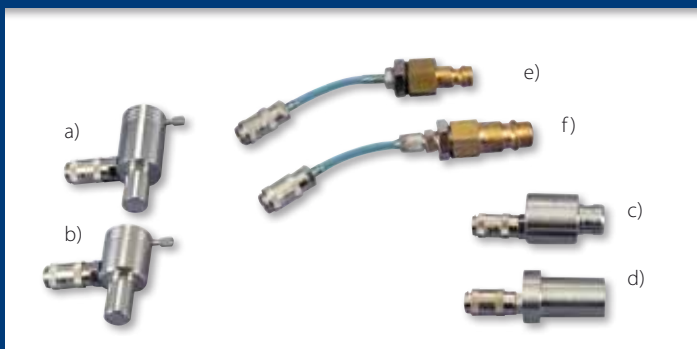

| Article description  | REF     |
|--|---------|
| a) Adapter K for direct connecting to Kavo turbine         | 401 084 |
| b) Adapter S for direct connecting to Sirona titan turbine | 401 089 |
| c) Connection to W+H Rotoquick                             | 401 077 |
| d) Bien Air Unifix   | 401 076 |
| e) Connection to EMS box                                   | 401 090 |
| f) Connection to lab coupling                              | 401 091 |

## Airsonic® Absorbo Box



### Handy absorber box

- Portable absorber box – the abraded material remains in the box and is completely collected in the filter
- Very low-noise and high-performance device
- Solid and durable design
- Problem-free cleaning by removable filter
- Ideal for practice and practice laboratory in combination with the Airsonic mini sandblaster (REF 401 080)
- No separate aspiration system required

#### Technical Data:

Size (W x H x D): 35.6 cm x 22 cm x 37 cm

Weight: only 2.8 kg

Equipment available on request

| Article description                   | REF     |
|---------------------------------------|---------|
| Airsonic Absorbo Box                  | 401 082 |
| Replacement filter separately         | 401 092 |
| Replacement pane available on request |         |



## Airsonic® Alu-Oxide

### Al<sub>2</sub>O<sub>3</sub> powder for sandblasting

| Article description       | Content | REF     |
|---------------------------|---------|---------|
| Airsonic Alu-Oxide, 50 µm | 500 g   | 605 084 |
| Airsonic Alu-Oxide, 90 µm | 500 g   | 605 086 |



### Root canal cement on zinc oxide – eugenol basis

- Inexpensive and fast alternative for more than 50 years
- Can be used separately or as a sealer in connection with Gutta Percha points
- Easily to be rotated into the canal
- Good adhesion to canal walls
- Definite, not absorbable filling with a chalk-like hardness after curing
- Antimicrobial effect gradually decreasing with curing
- Consisting of powder and liquid for mixing

| Article description | Content                 | REF     |
|---------------------|-------------------------|---------|
| Set                 | 10 g powder, 6 g liquid | 152 027 |
| Pulver separately   | 10 g                    | 152 028 |
| Liquid separately   | 6 g                     | 152 029 |



Free booklet available!

"In more than 8,800 EDP-registered vital extirpations in the period from 1985 – 1999 the treatment needed more than one session to be finished in only 22 cases (5 own, 17 assistant). I have not counted thousands of vital amputations and milk tooth endos."  
Dr. Robert Teeuwen

### Instruments for gentle root planning

- For curettage of the root surface in deep pockets, for bi- and/or tri-furcation and in the approximal area
- For removal of tightly adhesive granulations
- For removal of concrement (subgingival plaque)
- For periost ablation during flap surgery
- Non-cutting hexagonal head – as gentle as a manually operated device and as fast as diamonds
- At least 30 – 50 periodontias can be treated per instrument
- To be used with 7,000 – 10,000 rpm with light pressure and water spray

| Article description                           | REF     |
|---|---------|
| Intro kit with 6 pieces per shape (24 pieces) | 503 290 |
| Minikit with 1 piece per shape (4 pieces)     | 503 263 |
| Set with 3 pieces per shape (12 pieces)       | 503 264 |

#### Single shapes

| Article description | REF (3 pcs.) | REF (12 pcs.) |
|---------------------|--------------|---------------|
| I                   | 503 265      | 503 291       |
| II                  | 503 266      | 503 292       |
| III                 | 503 267      | 503 293       |
| IV                  | 503 268      | 503 294       |

#### Combination pack with 6 pieces each in 2 shapes

| Article description | REF     |
|---------------------|---------|
| I and II            | 503 295 |
| I and III           | 503 297 |
| II and IV           | 503 298 |
| III and IV          | 503 296 |

## N2® Endodontic Cement



Control radiography

## Desmoclean®



Desmoclean Original Size (two shaft lengths and two head sizes)

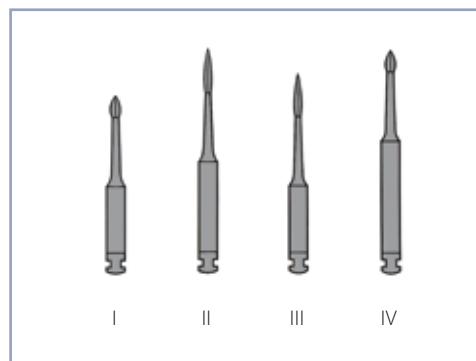

## Miraclean-Implant Black



### Cleaning instruments for implants

- Black coloured instruments for great contrast
- Double ended, in 4 special shapes
- Autoclavable and chemiclavable plastic material

| Article description          | REF     |
|------------------------------|---------|
| Set of 4 instruments         | 355 220 |
| Instrument separately: No. 1 | 355 221 |
| Instrument separately: No. 2 | 355 222 |
| Instrument separately: No. 3 | 355 223 |
| Instrument separately: No. 4 | 355 224 |

## Miraimplant®



### Parallel drilling aid for implants according to Dr. König

- Applicable for any implant system
- Parallel reciprocal implant adjustment
- Optional selection of implant positions in the horizontal according to surgical criteria
- Optimization of the prosthetic result
- Autoclavable

| Article description                        | REF     |
|--|---------|
| Kit (incl. 1 pilot drill and 2 guide pins) | 356 100 |
| Pilot drill 2 mm                           | 503 500 |
| Guide pins 1.9 mm                          | 356 101 |
| Guide pins 2.0 mm                          | 356 102 |
| Guide pins 2.1 mm                          | 356 103 |
| Guide pins 2.2 mm                          | 356 104 |

## Miraglu®



### Tissue adhesive for sealing of skin and mucosa injuries

- Excellent adhesive characteristics on humid tissue
- Cyano acrylate liquid in monomer form, polymerizes when getting into contact with water/body fluid
- Thin, absolutely dense film fixes wound borders tightly due to short setting time
- Wounds heal fast and without complications, no scarring, no need to take the stitches out, cosmetically impeccable
- Bactericidal and fungicidal effect, existing germ settlements get killed
- Suitable to cover up minor cuts

| Article description  | REF     |
|--|---------|
| Tube with 3 g, 20 fine dosing pipettes and 2 mixing dishes | 155 015 |

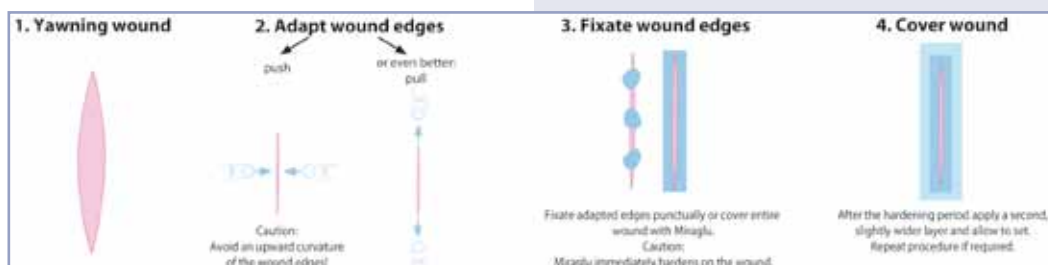

### Adhesive periodontal dressing based on cellulose

- To be applied directly to wounds, sutures and pressure spots
- Keeps out bacteria and assists the healing process
- Remains up to 30 hours and is self-dissolving
- Ideal for protection of wounds and sutures in implantology, periodontics, following extractions, in orthodontics and prosthodontics
- Ideal as a medicament carrier
- Patient-friendly as it stays soft, is odourless and neutral in taste



| Article description      | Content  | REF     |
|--------------------------|----------|---------|
| Reso-Pac                 | 25 g     | 155 011 |
| Reso-Pac value pack      | 5 x 25 g | 155 010 |
| Reso-Pac single portions | 50 x 2 g | 155 014 |

### Myrrh-benzoin tincture to support the wound healing

- Myrrh (tissue-firming and nurturing effect) helps in inflammations in the oral cavity and pharynx, in aftereffects of dental and gingival treatments, aphthae, etc.
- Benzoin and aloe have a nurturing healing effect
- Contains neither antibiotics nor corticosteroids
- No burning after application, pleasant taste, sticks to the mucosa for a long time due to its syrupy consistency
- After periodontal or surgical treatment
- For more than 100 applications

| Article description | Content | REF     |
|---------------------|---------|---------|
| Myzotect-Tincture   | 50 ml   | 155 005 |

#### For the patient's use at home

| Article description | Content   | REF     |
|---------------------|-----------|---------|
| Myzotect-Tincture   | 5 x 5 ml  | 155 006 |
| Myzotect-Tincture   | 10 x 5 ml | 155 007 |

### Micro nutrient gel for oral medical provision

- Oral medical provision with micro nutrients
- Beneficial healthy climate due to physical changes of the oral flora
- Ideal after surgery or periodontal treatments, in aphthae, lichen, florid herpes lesions and denture pressure spots
- Accelerates tissue regeneration
- Contains no alcohol, saccharin, menthol or preservatives
- Neutral taste

| Article description | Content | REF     |
|---------------------|---------|---------|
| Miradont-Gel        | 15 ml   | 155 000 |

## Reso-Pac®



## Myzotect®-Tincture



Very effective in combination with Reso-Pac



## Miradont®-Gel



## Protectoray



### X-ray shield

- X-ray protection shield for the patient
- Safe by 0.5 mm lead lining
- According to DIN 6813
- Approved by the German Institute of Radiation Safety, Munich, Germany
- Convenient for the patient – no heavy lead apron
- Easy exchange of handle



Protectoray wall mount

| Article description             | REF     |
|---------------------------------|---------|
| Shield and handle               | 656 127 |
| Wall holder, separately         | 656 128 |
| Handle separately, exchangeable | 656 701 |

## Emmenix® Film Holder

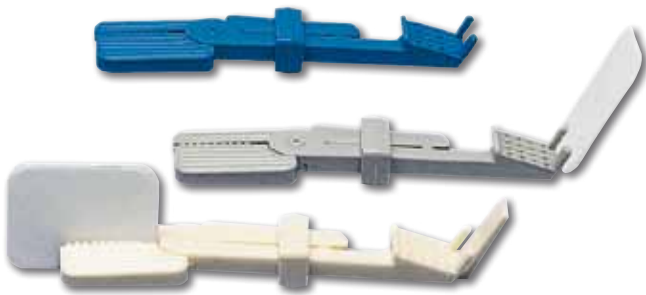

### Hygienic X-ray film holder

- Easy fixing of the film in the patient's mouth without the help of a finger (no irritation of mucosa, no gag reflex)
- Exact, as no bending of the film, no distortion of the picture
- For pictures of anterior teeth and molars, especially wisdom teeth
- Autoclavable, high-quality, unbreakable plastic
- In three colours: white, blue, grey

| Article description           | REF     |
|-------------------------------|---------|
| Pack with 3 holders, assorted | 656 300 |

## Emmenix® Flap



### Soft bite X-ray cushion

- Special foamed material with high adhesion
- Flap can be fixed to the film optimally and anywhere
- Ideal for bitewing, front, premolar and molar X-ray pictures

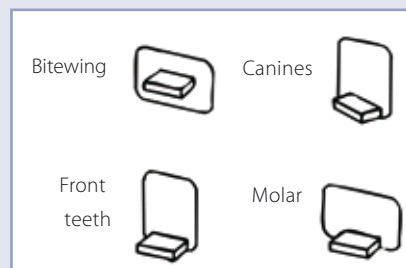

| Article description | Content  | REF     |
|---------------------|----------|---------|
| Emmenix-Flap        | 500 pcs. | 656 303 |

## Adhesive scale for X-ray films

- Gets stuck onto the X-ray film prior to picture taking
- Also applicable for digital X-ray devices
- Scale allows an exact reproduction of proportions, particularly for pictures taken with a certain time lag between them



| Article description | Content | REF     |
|---------------------|---------|---------|
| Test pack           | 5 pcs.  | 656 325 |
| Pack                | 20 pcs. | 656 326 |
| Econo pack          | 50 pcs. | 656 327 |

## X-ray marking pen

- Waterproof, special white ink
- Very exact, hard and thin tip



| Article description | REF     |
|---------------------|---------|
| Röntgomarker        | 656 322 |

## Liquid for stain removal

- Highly effective, long-approved
- Removes X-ray chemicals, iodine, rust, etc.

| Article description | Content | REF     |
|---------------------|---------|---------|
| X-Ray Stain Remover | 100 ml  | 656 220 |

## X-ray film viewer

- For any kind of X-ray picture
- Excellent illumination
- Can be installed as wall or table model
- In accordance with DIN 6856
- Available in two sizes

| Article description | Size       | REF     |
|---------------------|------------|---------|
| Panascope I (Maxi)  | 23 x 40 cm | 656 130 |
| Panascope II (Mini) | 17 x 30 cm | 656 131 |

## X-Ray Mesh



## Röntgomarker®



## X-Ray Stain Remover



## Panascope



# LaserHF® "comfort"

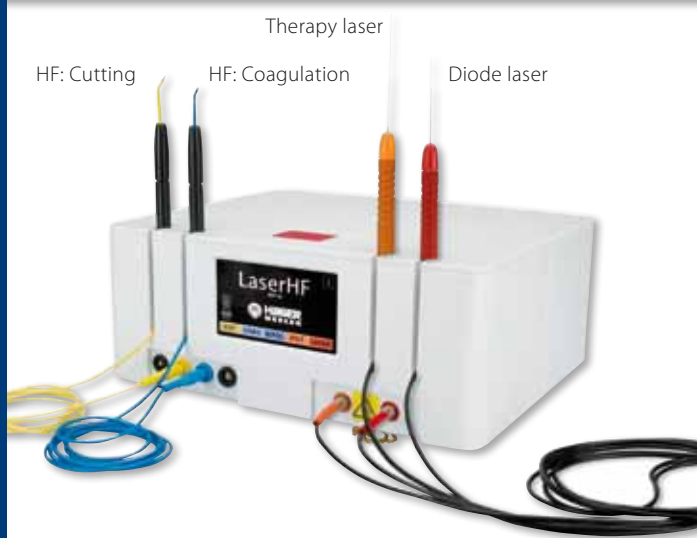

|                | For all applications: |    |         |
|----------------|-----------------------|----|---------|
|                | Laser                 | HF | LaserHF |
| Oral surgery   | ●                     | ●  | ●       |
| Periodontology | ●                     | ●  | ●       |
| Implantology   | ●                     | ●  | ●       |
| Endodontics    | ●                     | ●  | ●       |
| Bleaching      | ●                     | ●  | ●       |
| aPDT           | ●                     | ●  | ●       |
| LLLT           | ●                     | ●  | ●       |

## Radio Frequency Surgery: Optimal Cutting and Coagulation

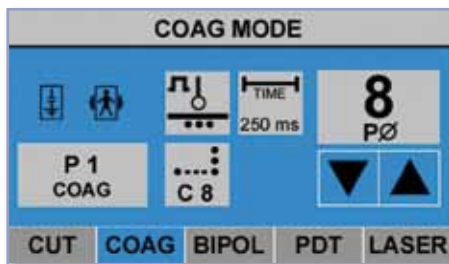
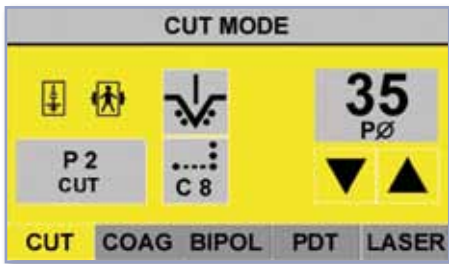

Cutting



Coagulation

### Laser and HF technology combination device

- I-Cube design with touch screen control
- Preset programmes for all possible applications
- Individual control available additionally
- Highest possible functionality and hygiene
- Touch screen monitor for easy operation and selection of programmes

#### LASER:

- Disinfection and cleaning of gingival pockets in periodontosis
- Disinfection after root canal preparation in endodontics
- Removal of soft tissue, e.g. in implant surgery in periimplantitis
- Wound healing, pain relief and desensitisation by Low Level Laser Therapy (LLLT)
- PDT laser (photodynamic therapy)
- Optionally: accelerated bleaching by laser therapy

#### RADIO FREQUENCY:

- Two hand pieces working independently of each other for exchangeable electrodes (colour-coded): cutting- and cutting-/coagulation wave (yellow), coagulation wave (blue)
- All type of treatments are possible due to the three forms of frequency: Cutting, cutting with coagulation for haemostasis, coagulation, pulse-driven coagulation to gently weld small tissue pieces
- Automatic voltage control
- hf Bipolar forceps optionally available

#### Technical data:

HF power max. 50 W  
 HF frequency 2.2 MHz  
 Laser PDT: 660 nm/100 mW  
 Laser 975 nm/6W - cw/pulsed  
 Measures (WxHxD) 30 x 13 x 25 cm  
 Power supply 230V/50Hz  
 HF 2.2 MHz/50 W – monopolar/bipolar  
 Weight ca. 3.5 kg



User Report  
(see Page 88)

#### Basic equipment

- 2 laser hand pieces (red for 6 W laser, orange for softlaser)
- 1 x fibre tip 200 µm (set of 3) + 1 x fibre tip 320 µm (set of 3)
- Safety glasses Lambda One (800 – 975 nm)
- Over-spec Skyline (green, 800 – 975 nm)
- Over-spec Skyline (blue, 657 – 660 nm)
- Patient's safety glasses
- 2 HF hand pieces (autoclavable)
- Set of electrodes (Nos. 40, 2, 13, 15, 31, 33)
- Neutral electrode
- Door contact/ interlock
- Foot pedal
- Instructions for use, medical product journal



Video

hf Bipolar Forceps to be ordered separately!

*The standard LaserHF device is still available.*

| Article description                  | REF     |
|--------------------------------------|---------|
| LaserHF "comfort"                    | 452 471 |
| LaserHF Standard                     | 452 462 |
| hf Bipolar Forceps, 110 mm angulated | 452 447 |
| hf Bipolar Forceps, 160 mm angulated | 452 455 |



Exposure



Endodontics



Frenectomy



Herpes



LLLT



aPDT

### Universal HF surgery device

- I-Cube design with touch screen control
- Preset programmes for all possible applications
- Additionally offers individual programming
- Standard fitting: connection for bipolar forceps
- Highest possible functionality and hygiene
- Touch screen monitor for easy operation and programme selection
- Two individually working hand pieces for exchangeable electrodes (colour marked): cutting and cutting/coagulation wave (yellow), coagulation wave (blue)
- Due to three frequency forms, every application is possible: cutting, cutting with coagulation for haemostasis, coagulation, pulsed coagulation for gentle welding of smaller tissue particles
- Automatic voltage regulation
- Bipolar forceps optionally available

#### Scope of delivery:

Device with 2 autoclavable hand pieces, foot pedal, set of electrodes (6 pieces: Nos. 40, 2, 15, 13, 31, 33), neutral electrode

hf Bipolar Forceps to be ordered separately!

#### Frequency + power

- 2.2 MHz, max. 50 W
- Voltage: 230 V/50 Hz
- Unipolar and bipolar
- Permanent/pulsed

#### Measures + weights

W 21.5 x H 11.7 x D 25 cm  
Weight 2.65 kg

| Article description                  | REF     |
|--------------------------------------|---------|
| hf1 Surg bipolar                     | 452 459 |
| hf Bipolar Forceps, 110 mm angulated | 452 447 |
| hf Bipolar Forceps, 160 mm angulated | 452 455 |

## LaserHF® "comfort"

Diode Laser 975 nm/6W: Periodontology, Endodontics and more

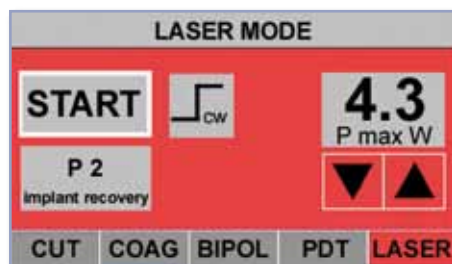

Therapeutic Laser: LLLT, aPDT

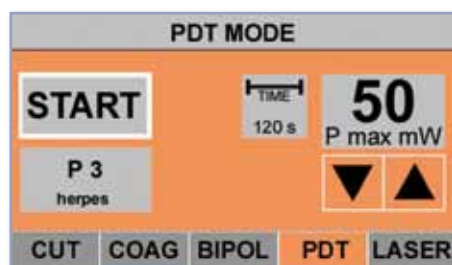

## hf1 Surg® bipolar

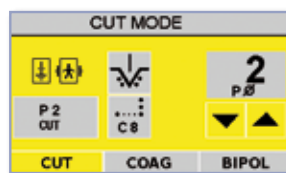

Source: Prof. Dr. med. Frank Liebaug

## hf Electrodes

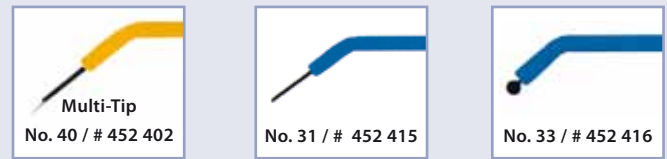
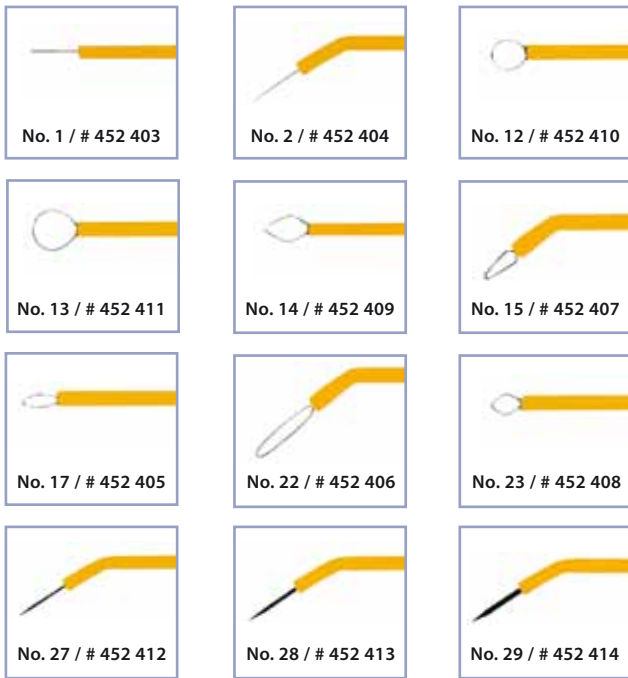

### hf Elepil set of electrodes



| Article description                | Content | REF     |
|------------------------------------|---------|---------|
| hf Elepil set of electrodes No. 54 | 3 pcs.  | 452 450 |
| hf Elepil set of electrodes No. 55 | 3 pcs.  | 452 451 |
| hf Elepil set of electrodes No. 56 | 3 pcs.  | 452 452 |
| hf Elepil electrodes, assorted     | 3 pcs.  | 452 453 |

## hf Neutral Electrode



### Coated earth plate for optimal conduction of the hf waves

- Disinfectable

Please mention the serial number of your old appliance!  
Further equipment available on request!

| Article description | with connector (new) | with connector (old) |
|---------------------|----------------------|----------------------|
| Length 1.50 m       | 452 421              | 452 419              |
| Length 2.0 m        | 452 422              | 452 420              |

## LaserHF® PDT-Solutions



### PDT-solution for disinfection

- Specifically for the treatment with the LaserHF "comfort"
- Photo-activated disinfection of root canals, periodontal pockets and for treatment of peri-implantitis
- For Laser 660 nm, Fibre 320 µm

| Article description       | Content                    | REF    |
|---------------------------|----------------------------|--------|
| LaserHF Endo-PDT solution | set of 3 pcs., 0.8 ml each | 155030 |
| LaserHF Endo-PDT solution | set of 3 pcs., 1.2 ml each | 155031 |

## hf Bipolar-Forceps



### Special forceps connection for the hf Surg devices

- Available in two lengths and shapes, without cable
- May be sterilised

#### Please note:

For first equipping, the hf Bipolar cable for the according hf Bipolar forceps needs to be ordered separately. Not included in the scope of delivery.

| Article description       | Form of Delivery | REF     |
|---------------------------|------------------|---------|
| hf Bipolar Forceps        | 110 mm straight  | 452 446 |
| hf Bipolar Forceps        | 110 mm angulated | 452 447 |
| hf Bipolar Forceps        | 160 mm straight  | 452 448 |
| hf Bipolar Forceps        | 160 mm angulated | 452 455 |
| Cable for Bipolar-forceps | 1.50 m           | 452 456 |



### Sterilisable fibre tips for the LaserHF device

- Available in 2 fibre strengths:  
ORANGE tip = 200 µm fibre, set with 3 pieces (sterile and individually packed)  
RED tip = 320 µm fibre, set with 3 pieces (sterile and individually packed)

| Article description                | Content | REF     |
|------------------------------------|---------|---------|
| LaserHF Fibre-Tip, red – 320 µm    | 3 pcs.  | 452 469 |
| LaserHF Fibre-Tip, orange – 200 µm | 3 pcs.  | 452 470 |

### Bending tool for glass fibre tips

- For 200 and 320 µm glass fibre tips
- Safe handling to enable the appropriate degree of bending without damaging the fibre

| Article description | REF     |
|---------------------|---------|
| LaserHF Curver      | 452 480 |

### Ceramic knife for scoring glass fibre tips

- Particularly suitable for scoring glass fibres
- Length of the ceramic blade 5 – 6 cm
- Please note: Ceramic blade is extremely sharp



| Article description  | REF     |
|----------------------|---------|
| LaserHF Fibre Cutter | 452 481 |

### Laser hand piece particularly for bleaching

- With integrated optic and 2.50 m long conducting fibre for activating bleaching material (in-office), e.g. for the Mirawhite Laser Bleaching Gel (REF 607 086)
- Special optic inside hand piece ensures easy use and homogenous activation of the bleaching material on the tooth surface

| Article description          | REF     |
|------------------------------|---------|
| LaserHF Bleaching Hand Piece | 452 472 |

### Dental bleaching gel for use with diode laser

- Bleaching gel adapted for wave lengths
- For diode lasers (810 – 980 nm) and ND: YAG laser (1064 nm)

(When using in combination with the LaserHF device, the bleaching gel gets activated with the special LaserHF bleaching hand piece (REF 452 472).

Set consists of: 1 box of bleaching powder 0.34 g (titanium dioxide), 9 ml H<sub>2</sub>O<sub>2</sub> 30% basis solution, 1 syringe Gingiva Protector 1 ml, mirafluor gel mint 25 ml, 2 applicators

| Article description       | REF     |
|---------------------------|---------|
| Mirawhite Laser Bleaching | 607 086 |

## LaserHF® Fibre-Tips



## LaserHF® Curver



## LaserHF® Fibre Cutter



## LaserHF® Bleaching Hand Piece



## Mirawhite® Laser Bleaching



## Bravo Portable II

Weight 300 g



### Strong portable micro motor

- Allows working without socket, ideal for home visits (weight 300 g)
- Infinitely variable motor with backward- and forward-running (0 – 25,000 rpm)
- Suitable for any standard hand and contra-angle piece with plane shaft without intra-spray and without light conductor
- For extraoral works only
- May be attached to the belt, space-saving
- Rechargeable, long-lasting battery recharging time 6 hours, up to 8 hours pure working time



| Article description                              | REF     |
|--|---------|
| Bravo Portable II with bag and battery recharger | 452 102 |

## Orbatec® Prophy



HST



Button fixation



Screw fixation

### Prophylaxis straight hand pieces and contra-angles

- For prophy cups and brushes with screw and button fixation
- From 0 – 5,000 rpm
- Fit any standard micro motor with plane shaft (e. g. Bravo Portable II)
- Autoclavable



| Article description            | REF     |
|--------------------------------|---------|
| WST (angle piece) button fixed | 452 152 |
| WST (angle piece) screw fixed  | 452 153 |
| HST R 4:1                      | 452 159 |

## Orbatec®



HST



WST

### Standard hand pieces and contra-angles

- Fit any standard micro motor with plane shaft
- Autoclavable

| Article description          | REF     |
|------------------------------|---------|
| WST (angle piece) 30,000 rpm | 452 150 |
| HST (hand piece) 40,000rpm   | 452 158 |

## Rubber cups for prophylaxis

- For single use
- Latex-free
- Available in two grades of hardness

| Article description       | Content | REF     |
|---------------------------|---------|---------|
| Screw on regular blue     | 50 pcs. | 605 832 |
| Screw on soft green       | 50 pcs. | 605 833 |
| Snap on regular blue      | 50 pcs. | 605 830 |
| Snap on soft green        | 50 pcs. | 605 831 |
| Contra Angle regular blue | 50 pcs. | 605 834 |
| Contra Angle soft green   | 50 pcs. | 605 835 |

## Disposable tips with rubber cups

- Latex-free
- In two hardnesses
- Only for hand pieces

| Article description | Content  | REF     |
|---------------------|----------|---------|
| Regular violet      | 100 pcs. | 605 836 |
| Soft green          | 100 pcs. | 605 837 |

## Stainless steel button mandrell for counter-angle

(delivery without Prophy-Cups)

| Article description | REF     |
|---------------------|---------|
| Prophy-Mandrell     | 605 672 |

## Micro spiral brush with stainless steel shaft

- For cleaning and polishing hard-to-reach areas, e.g. interdental spaces, etc.

### Rotoprox Mini

| Article description   | Content | REF     |
|-----------------------|---------|---------|
| Straight (20 mm long) | 50 pcs. | 605 792 |
| Pointed (21 mm long)  | 50 pcs. | 605 793 |

### Rotoprox

| Article description  | Content | REF     |
|--|---------|---------|
| Rotoprox for CA $\varnothing$ 2.0 mm X-fine/straight 27 mm long    | 10 pcs. | 605 719 |
| Rotoprox for CA $\varnothing$ 2.2 – 2.5 mm Fine/conical 27 mm long | 10 pcs. | 605 721 |

## Prophy-Cup®



## Prophy-Angles



## Prophy-Mandrell



## Rotoprox®



## Speed Labolight®

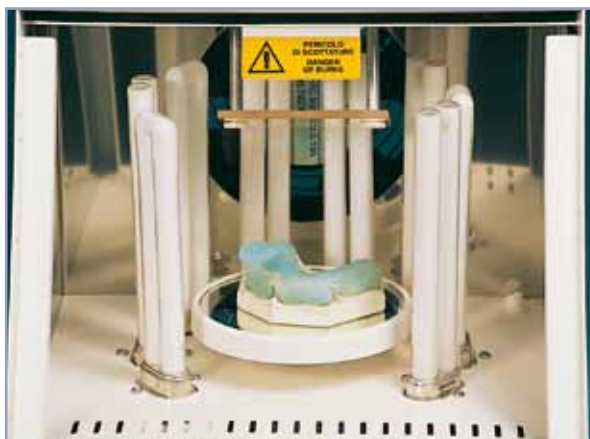

### Universal light-curing polymerisation device

- For nearly all light-curing dental materials
- Nanometer spectrum 320–550 nm
- Optimized light mixture for a homogenous and safe curing
- Circular arrangement of eight rod lamps around a turntable (dia. 14 cm) and one halogen lamp
- Interval turntable for an evenly light impact and curing
- Adjustable from one second to 99 minutes, protection against overheating, polymerisation temperature in the chamber does not exceed 40 °C
- Durable (approx. 1,000 hours), easy-to-exchange lamps
- Acoustic signal indicates end of polymerisation
- Operating hours counter

#### Technical data

|                    |  |
|--------------------|--|
| Supply voltage:    | 230 V, 50 Hz   |
| Power consumption: | 225 W  |
| Fuse:              | 1 x 2,5 A  |
| Lamps:             | 8 x 9 W T1 (white light)<br>4 x 9 W T8 (UV-A)<br>1 x 150 W (halogen) |
| Size (W x H x D):  | 250 x 290 x 240 mm   |
| Weight:            | 7 kg   |
| Turntable:         | dia. 14 cm   |

| Article description   | REF     |
|-----------------------|---------|
| Device incl. 13 lamps | 401 125 |

#### Replacement lamps, seperately

| Article description                   | REF     |
|---------------------------------------|---------|
| T1 (white light) 9W/71                | 901 002 |
| T8 (UV-A) 9W/PLS-10                   | 901 003 |
| Halogen                               | 901 004 |
| Set (4 x T1 and T8 each, 1 x halogen) | 901 001 |

## Bravo TD III



Foot control



AC motor

### Collector-free AC motor (3-phase motor)

- Flexible device for smaller works
- For all conventional hand and angle pieces
- Speed infinitely and precisely variable from 1,000 – 30,000 rpm
- Forward and reverse rotation, with optic indication
- Solid, low-maintenance plastic body
- For extraoral works only

#### Technical data

|                   |                   |
|-------------------|-------------------|
| Supply voltage:   | 230 V             |
| Motor capacity:   | max. 40 W         |
| Size (H x W x D): | 88 x 185 x 188 mm |
| Weight:           | ca. 2.5 kg        |

| Article description | REF     |
|---------------------|---------|
| Bravo TD III        | 452 106 |

### Quiet denture cleaning device

- Aesthetic surface cleaning using rotating polishing needles in combination with a cleansing liquid – no material abrasion
- Integrated timer allows individual cleaning times
- Additional magnet keeps the needles in the container when replacing the liquid
- Autoclavable container

#### Technical data

|          |       |            |           |
|----------|-------|------------|-----------|
| Weight:  | 2 kg  | Frequency: | 50/60 Hz  |
| Output:  | 35 W  | Rotation:  | 1,700 rpm |
| Voltage: | 230 V |            |           |

| Article description   | REF     |
|---|---------|
| Device with container, 50 g polishing needles (ø 0.6 mm) 1 litre of liquid and 1 magnet | 401 136 |
| 50 g polishing needles, nickel-free stainless steel ø 0.6 mm for dentures               | 304 014 |
| Speedo-Clean Liquid, 1 litre  | 554 106 |
| Container separately  | 355 419 |
| Magnet separately   | 304012  |

### Sterilisation device

- Does not replace an autoclave, however, ideal to sterilize instruments, e. g. for endodontics, within seconds directly before treatment
- To prevent fogging of mouth mirrors
- Special heating element warms glass beads up to 230 °C and keeps the temperature constant without heating the outer body of the device
- Removable chamber, easy cleaning
- Size (W x H x D): Maxi 190 x 130 x 140 mm, chamber ø 50 mm  
Mini 165 x 115 x 115 mm, chamber ø 35 mm

#### Device complete with glass beads:

| Article description           | REF     |
|-------------------------------|---------|
| Mini, incl. 100 g glass beads | 452 300 |
| Maxi, incl. 200 g glass beads | 452 303 |

#### Glass bead refill pack

| Article description | Content | REF     |
|---------------------|---------|---------|
| Mini                | 100 g   | 452 301 |
| Maxi                | 200 g   | 452 304 |

### Fully synthetic cleaning product for cleansing and high-gloss polish of plastic artificial dentition

- Aesthetically upgrades the presentation of your prosthetic works
- For the removal of polishing agent and monomer residues from prosthetic work
- Spray on and leave for a short while before wiping off with a soft cloth
- Pleasant flavour: mint

| Article description | Content | REF     |
|---------------------|---------|---------|
| Protho Clean        | 75 ml   | 554 220 |

## Speedo-Clean®



## Glass Bead Heater



## Protho Clean®



## Armatron® Pro



### Convenient burner for one-hand operation

- Activation of ignition with the heel of hand
- Unique, extra reliable ignition system
- Infinitely variable flame, from approx. 800 – 1,300 °C
- Mobile handling allows working with the flame upside down
- Refillable with APT gas (not included in scope of delivery)

| Article description | REF     |
|---------------------|---------|
| Armatron Pro        | 401 002 |

## APT III Burner



### Convenient burner with one-hand operation

- Activation of ignition without having to put the instrument down
- Extra reliable ignition system
- Infinitely variable flame
- Transport securing
- Refillable with APT gas (not included in scope of delivery)



| Article description | REF     |
|---------------------|---------|
| APT III Burner      | 401 001 |

## APT Gas



### Refill gas

- With various adapter tips to refill APT, Armatron Pro and Blue Flame burners, etc.
- Not suitable for Kisag Burner

| Article description | Content | REF     |
|---------------------|---------|---------|
| APT Gas             | 200 ml  | 605 143 |

### ***Inexpensive dental burner for dentist and laboratory***

- Small, handy burner (170 g)
- Easy adjustment and control of temperature and flame, infinitely variable
- Burning temperature 1,300 °C, burning time approx. 60 – 70 minutes
- Refillable with APT gas (not included in scope of delivery)



| Article description | REF     |
|---------------------|---------|
| Miratorch           | 401 010 |

### ***Handy burner for dental practice and laboratory***

- Easy, practical one-hand operation
- Automatic and reliable ignition
- Solid freestanding burner, 15 cm only
- Flame temperature infinitely variable from approx. 800 – 1,300 °C, max. burning time approx. 35 minutes
- Refillable with APT gas (not included in scope of delivery)
- Diverse fields of application in household use

| Article description | REF     |
|---------------------|---------|
| Blue-Flame 1500     | 401 006 |

### ***Gas burner for dental practice and laboratory***

- Flame temperature infinitely variable from approx. 750 – 1,150 °C
- One filling for a burning time of 5–6 hours
- With the Swiss SVGW sign (equivalent to the German GS sign)
- Refill with Kisag gas (No. 605140) only

| Article description                 | REF     |
|-------------------------------------|---------|
| Kisag Burner incl. 400 ml Kisag gas | 401 005 |
| Kisag gas, 400 ml                   | 605 140 |

## Miratorch®



## Blue-Flame 1500



## Kisag Burner



## Integra® Cart

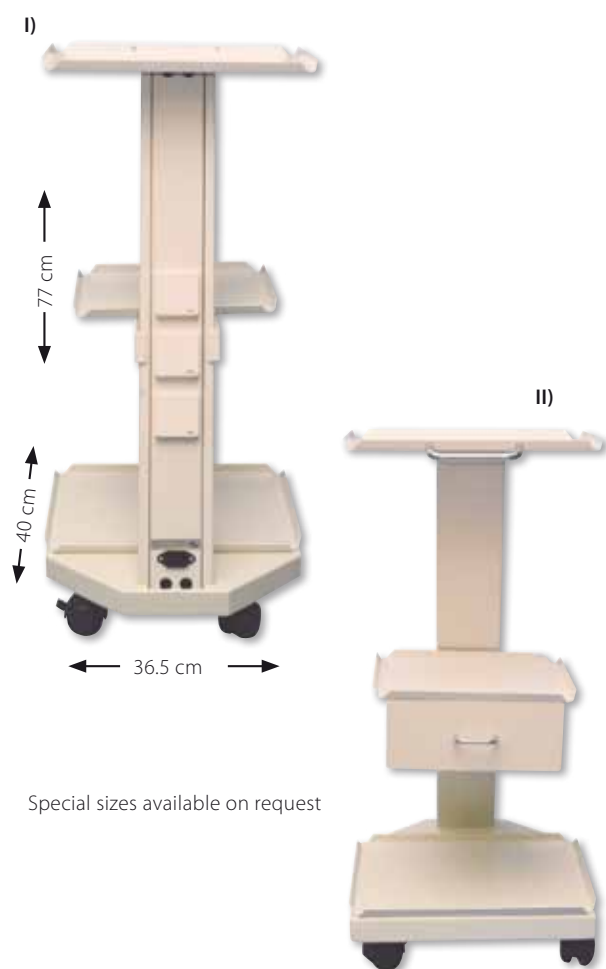

Special sizes available on request

### Multifunction cart in two models

- Elegant, solid metal design with three covered sockets embedded in the column
- Three trays
- Removable power supply cable
- Four ball casters
- Colour: beige (RAL 9002)
- Total size (H x W x D): 770 mm x 365 mm x 400 mm

#### Model I

|              |                 |                |
|--------------|-----------------|----------------|
| Upper tray:  | outside (B x T) | 35 x 26 cm     |
|              | inside (B x T)  | 33.5 x 24.5 cm |
| Centre tray: | outside (B x T) | 28 x 25 cm     |
|              | inside (B x T)  | 26.5 x 23.5 cm |
| Lower tray:  | outside (B x T) | 36.5 x 29 cm   |
|              | inside (B x T)  | 25 x 27.5 cm   |

Weight: 14.3 kg

| Article description            | REF     |
|--------------------------------|---------|
| Integra Cart I (incl. 3 trays) | 460 101 |

#### Model II

- Same as model I, but centre tray is equipped with roller bearing material drawer with handle
- Drawer cover designed as tray, can be used as deposit surface for one device

|              |                    |                |
|--------------|--------------------|----------------|
| Drawer tray: | outside (B x T)    | 28 x 25 cm     |
|              | inside (B x T)     | 26.5 x 23.5 cm |
| Drawer:      | height             | 9.5 cm         |
|              | inside (H x B x T) | 9 x 20 x 19 cm |

Weight: 14.8 kg

| Article description                                 | REF     |
|---|---------|
| Integra Cart II (incl. 3 trays and material drawer) | 460 102 |

## Integra® Fit-On Tray



### Tray for the column of surgery lamp

- Suitable for all accessory devices (e. g. hf1 Surg bipolar), which are needed chairside
- Rotatable by two swivel-joints
- Handle mountable on long or short side
- Elegant and easy to mount to all columns
- Solid metal tray, max. load 3 kg
- Colour RAL 9002

#### Measures

|                  |                |
|------------------|----------------|
| Outside (W x D): | 35 x 26 cm     |
| Inside (W x D):  | 33.5 x 24.5 cm |
| Swivel arm:      | 23 cm long     |

| Article description                   | REF     |
|---------------------------------------|---------|
| Integra Fit-On Tray with standard arm | 460 103 |

**The Fit-On Tray has to be ordered together with the fitting pipe flange to allow mounting.**

| Pipe flange incl. internal ring | ø mm | REF     |
|---------------------------------|------|---------|
| For Planmecca                   | 42   | 460 104 |
| For other units                 | 45   | 460 105 |
| For Ritter                      | 48   | 460 106 |
| For Eurodent                    | 50   | 460 107 |
| For Sirona/Siemens              | 52   | 460 108 |
| For Kavo/Flex Integral          | 55   | 460 109 |
| For Ultradent/Faro              | 60   | 460 110 |



**Patented small device for limitation of preparation depth**

- Determination of dentine thickness above the pulp during preparation
- Easy, fast measurement by scanning the dentine surfaces
- Convenient and safe indication by LED
- Safe preparation, especially of juvenile teeth with a wide pulp cavity, and elongated and tilted teeth
  - green - riskless preparation
  - yellow - further preparation still possible
  - orange - limit range for a safe preparation
  - red - endangerment of pulp vitality

| Article description                                       | REF     |
|---|---------|
| Device incl. 25 silicone tips, 2 electrodes and batteries | 452 035 |

**Prepometer®**



*Our laboratory products can be found on [www.hagerwerken.de/dentalproducts/download](http://www.hagerwerken.de/dentalproducts/download)*

*or request the laboratory catalog using the fax form at the end of this catalog.*



*Just request additional information via fax.*

**The Catalog Lab No. 13**



**HÄGER  
WERKEN**

Dentalprodukte weltweit  
Dental Products Worldwide



Laboratory  
Catalog

## Mira-Clin P®

### Approved prophylaxis paste with fine granulation

- For professional tooth cleaning in the dental surgery
- Low abrasion with optimal cleaning effect
- Pleasant fruit taste
- Free of fluoride and menthol



| Article description  | Content | REF     |
|--|---------|---------|
| Mira-Clin P  | 250 g   | 605 656 |
| Box with 200 dishes, 2 g each and stainless steel finger ring II |         | 605 658 |
| Finger ring II separately  |         | 605 444 |

## Dapp-a-Way

### Disposable dappen dishes

- Set with 1,000 plastic dishes



| Article description                              | Content    | REF     |
|--|------------|---------|
| Dapp-A-Way incl. 1 finger ring (stainless steel) | 1,000 pcs. | 605 445 |
| Replacement finger ring                          |            | 605 446 |

## Prophy-Ring

### Stainless steel holder for dappen dishes

- Practical metal ring for attaching to the finger
- For chairside application



| Article description | REF     |
|---------------------|---------|
| Prophy-Ring         | 605 657 |

## Mira Clean®

### Mouth rinsing tablets for dissolving

- Refreshing, slightly antiseptic, cooling
- The little additional service for the patient
- Also ideal for prophylaxis with air scalers
- Pastilles dissolve completely within max. three minutes
- In two pleasant flavours: mint and thymol



| Article description | Content         | REF     |
|---------------------|-----------------|---------|
| Mint (green)        | 1,000 pastilles | 605 504 |
| Thymol (pink)       | 1,000 pastilles | 605 505 |

### Application tray for fluoride gel

- Made of light, flexible plastic
- With level indicator
- Double tray for simultaneous treatment of maxilla and mandible
- In yellow colour contrasting any gel

| Article description | Content | REF     |
|---------------------|---------|---------|
| Small               | 50 pcs. | 605 620 |
| Medium              | 50 pcs. | 605 621 |
| Large               | 50 pcs. | 605 622 |

### Fluoride gel for intensive caries prophylaxis

- Increases the acid resistance of the enamel
- Decreases plaque formation
- Accelerates the remineralisation
- mirafluor-gel with 1.23 % fluoride
- mirafluor-k-gel with 0.6 % fluoride is particularly suited for children aged 6 or older

| Article description         | Content | REF     |
|-----------------------------|---------|---------|
| mirafluor-gel, mint         | 250 ml  | 605 800 |
| mirafluor-gel, strawberry   | 250 ml  | 605 801 |
| mirafluor-k-gel, cola       | 250 ml  | 605 802 |
| mirafluor-k-gel, strawberry | 250 ml  | 605 803 |

### Fluoride varnish on emulsion basis with 0.15 % fluoride

- Free of solvents
- For precise application, can also be applied in a humid environment
- Fluoride concentration clearly lower than in comparable varnishes: 0.15 % fluoride
- Aqueous polymer layer allows fluorides to diffuse and is decomposed by the saliva without any problems

| Article description                        | REF     |
|--|---------|
| 5 ml bottle and 20 Mirabrush brushes       | 605 810 |
| Mirabrush brush (blue/flat), 100 pcs.      | 605 461 |
| Mirabrush brush (yellow/pointed), 100 pcs. | 605 460 |

## Mirafluor®-Tray

With level indicator

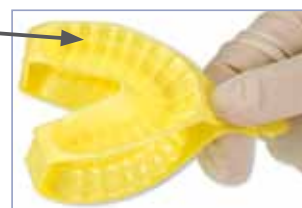

## mirafluor®-gel



## mirafluor®-k-gel (for children)

## Mirafluorid®

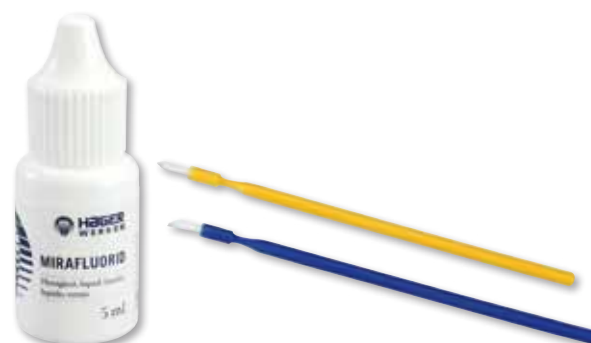

## Mc Tooth® Mirror



### *Molar-shaped pop-up mirror*

- For prophylaxis in children and adults
- Measure ca. 17 x 14 cm

| Article description | REF     |
|---------------------|---------|
| McTooth Mirror      | 707 094 |

## Mira-Duo®



### *Double-sided patient mirror*

- Front 1:1, back twofold magnification
- ø 13 cm
- May be used as hand or table mirror
- Ideal for control – especially in prophylaxis

| Article description | REF     |
|---------------------|---------|
| Mira-Duo            | 605 682 |

## Toothbrushing Model



### *Enlarged demonstration model*

- For demonstration of the correct brushing technique
- With oversized toothbrush
- Ideal for motivation of children



| Article description     | REF     |
|-------------------------|---------|
| Model incl. super brush | 355 636 |
| Super brush separately  | 355 637 |

## Study Model Demo Implant



W x H x D:  
55 x 75 x 32 mm

### *Study model for implantology*

- Provides patients with a visual aid to an implant procedure



| Article description      | REF     |
|--------------------------|---------|
| Study Model Demo Implant | 355 644 |

### High-quality transparent demonstration model with tooth diseases

- Demonstration of various tooth defects and courses of carious defects
- Manufactured in 1:1 scale
- Teeth not removable

#### Model De Luxe

- De Luxe model featuring malocclusion of lower wisdom teeth
- Several examples of inflammatory root processes
- Illustration of an implant work with build-up



| Article description             | REF     |
|---------------------------------|---------|
| Study Model Transparent De Luxe | 355 642 |
| Study Model Transparent Plus    | 355 640 |

### Demonstration model child

- Very clear illustration of deciduous and permanent teeth
- Maxilla and mandible with ten deciduous teeth
- Manufactured in 1:1 scale
- Teeth not removable
- Dental disease
- Interproximal and molar caries
- broken deciduous front tooth with root disease

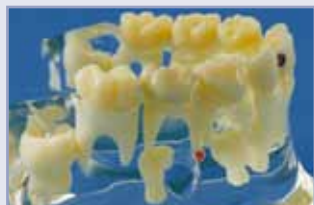

| Article description           | REF     |
|-------------------------------|---------|
| Study Model Transparent Child | 355 643 |

### High-quality transparent demonstration model

- All 32 teeth can be removed from the alveole
- Well visible root anatomy
- Made of transparent, solid plastic
- Manufactured in 1:1 scale



| Article description     | REF     |
|-------------------------|---------|
| Study Model Transparent | 355 641 |

## Study Model Transparent Plus and De Luxe



## Study Model Child



## Study Model Transparent



## From the practice for the practice



miradent catalog

## mirasensitive hap<sup>+</sup>



## Dear Dental Practitioners

Our miradent brochure contains detailed information about our oral health care products. Our prophylaxis line has been developed together with dentists to fit your patients needs. In many countries they are also available in pharmacies.

When ordering miradent prophylaxis products, please indicate your desired language in addition to the article number, as we offer our home care products in various languages.

Visit us at [www.miradent.de](http://www.miradent.de)

## Intensive care for the preservation of sensitive teeth

- Sealing of open tubuli
- Builds up biomimetic enamel due to 30 % hydroxyapatite
- Calms the tooth nerve due to potassium ions
- Daily treatment to protect teeth from painful stimuli
- Contains fluoride and xylitol to prevent decay and tooth neck decay
- Mild and fresh taste
- RDA-value: 20
- Sodium fluoride 1450 ppm



| Article description                    | Content | REF     |
|--|---------|---------|
| mirasensitive hap <sup>+</sup>         | 50 ml   | 630 169 |
| mirasensitive hap <sup>+</sup> Display | 8 pcs.  | 635 191 |

## Mirawhite<sup>®</sup> oxygen

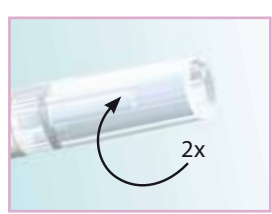

## Effective whitening for sensitive teeth

- Hygienic pen application
- Tooth whitening without peroxide with active oxygen
- Soft to the enamel and the gingiva
- Tooth whitening by up to five shades
- Application period 7 days, twice per day



| Article description      | Content    | REF     |
|--------------------------|------------|---------|
| Mirawhite oxygen         | 1.8 ml     | 631 097 |
| Mirawhite oxygen Display | 8 packages | 635 194 |

For office bleaching, we recommend mirawhite laser bleaching page 57

## Dental care chewing gum

- Sweetened with 100% xylitol
- Free of aspartame, sorbitol, lactose and gluten
- Helps against bad breath
- Spearmint and peppermint flavours contain menthol
- Promotional HV display made of acrylic available on request

### Reclosable tube with 30 gums

| Article description | Content       | REF     |
|---------------------|---------------|---------|
| Spearmint           |               | 630 079 |
| Peppermint          |               | 630 080 |
| Cinnamon            |               | 630 081 |
| Fresh Fruit         |               | 630 082 |
| Cranberry           |               | 630 090 |
| Green Tea           |               | 630 091 |
| Display, assorted   | 6 x 12 tubes. | 635 092 |

### Dispenser box with 200 packs of 2 dragees each

| Article description                  | REF     |
|--------------------------------------|---------|
| Dispenser box chewing gums, assorted | 635 069 |

## Tooth friendly drops sweets with 100% natural Xylitol – sugar free

- Anti caries and anti plaque effect, re-mineralising
- Stimulates saliva production (ideal in xerostomia)
- Free of aspartame, sorbitol, lactose and gluten
- Suitable for diabetics
- Cool and refreshing taste

| Article description  | Content        | REF     |
|----------------------|----------------|---------|
| Xylitol Drops melon  | 60 g / 26 pcs. | 630 170 |
| Xylitol Drops cherry | 60 g / 26 pcs. | 630 171 |
| Xylitol Drops mint   | 60 g / 26 pcs. | 630 172 |

### Dispenser box with 100 drops

| Article description     | REF     |
|-------------------------|---------|
| Dispenser box, assorted | 635 183 |

## Xylitol – a 100% natural and healthy sugar substitute

- For sweetening of cold and hot drinks, fruit, cereals or for baking
- Same sweetening effect as sugar
- Purely natural product, gluten-free and not genetically modified
- 40% less calories than saccharine



friendly for teeth

| Article description | Content   | REF     |
|---------------------|-----------|---------|
| Xylitol powder      | 350 g     | 630 119 |
| Xylitol powder      | 100 x 4 g | 630 120 |
| Xylitol powder      | 5 x 350 g | 635 080 |

## Xylitol Chewing Gum



## Xylitol Drops



## Xylitol Powder



## Alpha-Ion® Toothbrush



Interbrush



Periobrush

### Plaque removal by ion effect

- Negatively charged ions in the bristles are released during tooth brushing
- The positively charged ions in the plaque are attracted
- Remineralisation of the enamel due to medical hydroxyapatite (mHAP)
- Gentle cleaning with low abrasion
- Every brush comes with a protection cap

Interbrush (pink): "medium" with protruding bristle crown for additional thorough cleaning of the interdental spaces

Periobrush (blue): "super soft" for the cleaning of hypersensitive teeth, for sensitive gingiva (e. g. periodontitis) as well as after gingival treatment

| Article description | REF     |
|---------------------|---------|
| Interbrush          | 630 112 |
| Periobrush          | 630 113 |

## Happy Morning® Travel Kit



### Dental care travel kit companion

- Toothbrush and 3 g tube with fresh mint toothpaste
- On the way and in between
- Toothbrush and tube hygienically blister-packed as set
- Toothbrushes in five different colours, assorted, 5 x 10 pcs.

| Article description      | Content | REF     |
|--------------------------|---------|---------|
| Happy Morning Travel Kit | 50 pcs. | 605 410 |

## Happy Morning® De Luxe



### Happy Morning®

### Toothbrush with good cost-effectiveness

- Rounded bristles and angled handle
- Bristle size medium
- Separately packed

| Article description   | Content | REF     |
|-----------------------|---------|---------|
| Happy Morning De Luxe | 50 pcs. | 605 443 |

### Disposable toothbrush

- Ideal for brushing teeth in the dental practice before treatment, on short trips, etc.
- Hygienically and separately packed

| Article description         | Content  | REF     |
|-----------------------------|----------|---------|
| Impregnated with toothpaste | 100 pcs. | 605 401 |
| Without toothpaste          | 100 pcs. | 605 403 |



with toothpaste



without toothpaste

2.5 cm



### Fluoride gel for intensive caries prophylaxis

- Caries prophylaxis with sodium fluoride
- Intense enamel hardening
- Efficient acid resistance
- mirafleur-gel with 1.23 % fluoride
- mirafleur-k-gel with 0.6 % fluoride is particularly suited for children aged 6 or older



| Article description         | Content         | REF     |
|-----------------------------|-----------------|---------|
| mirafleur-gel, mint 25 ml   | 25 ml           | 605 813 |
| mirafleur-k-gel, strawberry | 25 ml           | 605 812 |
| HV-Display 6 tubes each     | 6 packages each | AK-1204 |

### High-quality amino fluoride toothpaste

- Amino fluoride toothpaste
- RDA value 17
- Fluoride content 1,250 ppm
- Fine abrasive silica particles
- Mild mint flavour

| Article description | Content    | REF        |
|---------------------|------------|------------|
| mirafleur c         | 100 ml     | 630 083    |
| mirafleur c Display | 8 packages | 635 195 GB |

### Intensive cleaning and nano-sealing, for brilliant white teeth

- Soft cleaning and polishing particles remove plaque and discolouration
- Micro cracks are filled with particle clusters
- Caries protection by fluoride (1,000 ppm)
- Resists new plaque adhesion
- For evenly polished and brilliant teeth
- Application: 1 – 2 x per week

| Article description     | Content    | REF     |
|-------------------------|------------|---------|
| Mirawhite gelée         | 100 ml     | 631 093 |
| Mirawhite gelée Display | 9 packages | 635 177 |

## mirafleur®-gel



## mirafleur®-k-gel (for children)



## mirafleur® c



## Mirawhite® gelée



## Mirafloss®



### Dental floss/tape

- For specially thorough cleaning of interdental spaces
- Extremely tear-proof, will not fray
- Tape: not waxed, but consisting of PTFE, glides perfectly through even the narrowest interdental spaces

| Article description | Content | REF     |
|---------------------|---------|---------|
| Tape                | 20 m    | 630 022 |
| chx-Tape            | 20 m    | 630 078 |
| Tape unwaxed        | 20 m    | 630 077 |

## Mirafloss® Implant chx



### Floss fibres from the roll

- 50 floss fibres (15 cm each), rolled up in a handy dispenser
- Stiff ends facilitate threading
- Fleecy centre part saturated with 0.2 % chx solution
- Ideal for the cleaning of implants and bridges
- Available in two thicknesses: fine (ø 1.5 mm) and medium (ø 2.2 mm)



| Article description | REF     |
|---------------------|---------|
| Fine (pink)         | 630 134 |
| Medium (turquoise)  | 630 135 |

## Mirafloss® Big



### Wall-mountable dispensing box

- Ideal for professional use in practice
- One-handed operation using sharp metal edge
- Refillable

| Article description                        | Content   | REF     |
|--|-----------|---------|
| Mirafloss Big (white, waxed / green, mint) | 2 x 200 m | 605 735 |
| Refills: green, mint                       | 200 m     | 605 737 |
| Refills: white, waxed                      | 200 m     | 605 736 |
| Refills: white, unwaxed                    | 200 m     | 605 738 |

## Mirafloss® interspace



**Cut mechanism**  
For comfortable cutting of remaining floss

### Dental floss holder with fluoridated floss

- Patented dental floss holder, clinically tested
- Easy use of floss even in hard-to-reach interdental spaces
- Fluoridated PTFE floss glides particularly well
- Economic in use
- Refillable
- Deposit function: hygienic depot in the handle for keeping refillable dental floss

| Article description | Content | REF     |
|---------------------|---------|---------|
| Blue                | 1 pcs.  | 630 053 |
| Red                 | 1 pcs.  | 630 054 |
| Refill, 2 x 10 m    | 2 rolls | 630 055 |

## Convenient combination of dental floss and toothpick

- 30 pcs.: handy resealable box, 100 pcs.: separately blister-packed

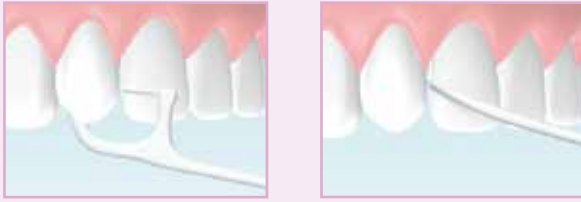

| Article description            | Content  | REF     |
|--------------------------------|----------|---------|
| Zahnpick, resealable box       | 30 pcs.  | 630 039 |
| Zahnpick, individually wrapped | 100 pcs. | 605 637 |

## Interdental brush in pocket size

- Adjustable angles for flexible use
- Antibacterial effect due to chx impregnation of bristles (approx. 0.15 %)
- Coated special wire with ultra-fine bristles
- Hygienic cap also to be used as handle extension



Resealable box



Click-in display

| Article description                   | 6 pcs.  | 25 pcs. |
|---------------------------------------|---------|---------|
| Pink                                  | 630 092 | 630 105 |
| Yellow                                | 630 093 | 630 106 |
| White                                 | 630 094 | 630 107 |
| Green                                 | 630 095 | 630 108 |
| Bordeaux                              | 630 097 | 630 110 |
| Orange                                | 630 096 | 630 109 |
| assorted                              | 630 098 | -       |
| Click-In Display with 9 pcs. assorted |         | 635 166 |

## Zahnpick®



Resealable box



## I-Prox® chx



| Design  | Insert Cylinder | Cleaning Cylinder |
|---------|-----------------|-------------------|
| xx-fine | Ø 0.5 mm        | Ø 1.8 mm          |
| x-fine  | Ø 0.6 mm        | Ø 1.9 mm          |
| fine    | Ø 0.7 mm        | Ø 2.5 mm          |
| medium  | Ø 0.8 mm        | Ø 3.5 mm          |
| large   | Ø 0.8 mm        | Ø 5.0 mm          |
| conical | Ø 0.8 mm        | Ø 2.5 – 5.0 mm    |



## Pic-Brush® Set



## Pic-Brush® Intro Kit



### Interdental brush holder with one brush

- Connector system with conical neck for a safe fit
- Ergonomically shaped handle with 120° angle
- Flexible high-quality brushes, coated special wire, ultra-fine bristles
- Protection against injuries due to elaborate loop technique of wire end
- Holder end with storage compartment for brushes and additional clip-on function
- Also for cleaning of brackets, bridges and dentures

| Article description          | Colour           | REF     |
|------------------------------|------------------|---------|
| Holder with 1 brush          | blue transparent | 631 002 |
| Holder with 1 brush          | pink transparent | 631 003 |
| Holder with 1 brush          | dark blue        | 631 001 |
| Click-In Display with 9 pcs. | assorted         | 635 167 |



### Interdental brush holder with four brushes in four thicknesses

| Article description   | Colour           | REF     |
|-----------------------|------------------|---------|
| Holder with 4 brushes | blue transparent | 631 005 |
| Holder with 4 brushes | pink transparent | 631 006 |
| Holder with 4 brushes | dark blue        | 631 004 |

## Pic-Brush® Replacement Brushes

### Design

|                            |  |           |  |                |
|----------------------------|--|-----------|--|----------------|
| <b>pink</b><br>xx-fine     |  | ø 0.45 mm |  | ø 1.6 mm       |
| <b>yellow</b><br>x-fine    |  | ø 0.5 mm  |  | ø 1.8 mm       |
| <b>white</b><br>fine       |  | ø 0.6 mm  |  | ø 2.0 mm       |
| <b>green</b><br>medium     |  | ø 0.8 mm  |  | ø 2.2 mm       |
| <b>blue</b><br>large       |  | ø 0.8 mm  |  | ø 3.0 mm       |
| <b>bordeaux</b><br>x-large |  | ø 0.8 mm  |  | ø 6.5 mm       |
| <b>orange</b><br>conical   |  | ø 0.5 mm  |  | ø 2.5 - 5.0 mm |

### In hygienic storage box or as practice refills



| Article description | 6 pcs.  | Refills 25 pcs. bag |
|---------------------|---------|---------------------|
| Pink                | 631 013 | 607 060             |
| Yellow              | 631 014 | 607 061             |
| White               | 631 015 | 607 062             |
| Green               | 631 016 | 607 063             |
| Blue                | 631 017 | 607 064             |
| Bordeaux            | 631 050 | 607 065             |
| Orange              | 631 018 | 607 066             |

### Pointed brush for precise use

- Efficient cleaning of gingival border and gingival pockets with tapered bristle tuft
- Ideal for the cleaning of orthodontic appliances, implants and interdental spaces
- Optimal application of preparations
- Finger-grip handle (14 cm) with two click-on angles (60° and 120°)
- Holder end with storage compartment for brushes



Gingival pocket      Implants      Brackets

| Article description                    | REF     |
|--|---------|
| Holder blue transparent incl. 4 tips   | 631 032 |
| Holder pink transparent incl. 4 tips   | 631 033 |
| Replacement brushes, 4 pcs.            | 631 034 |
| Click-In Display with 9 pcs., assorted | 635 168 |

### Interdental care set

- For efficient cleaning of sulcus, interdental spaces and bridges
- Finger-grip handle allows safe and precise use
- Holder end of sulcus brush with storage compartment for replacement brushes
- Anti-fog coated mouth mirror for immediate self control
- I-Prox C for specially persistent adherences

Set includes:  
 miradent mouth mirror, I-Prox C (double-ended toothscaler/cleaner)  
 I-Prox P sulcus brush

| Article description          | REF     |
|------------------------------|---------|
| Set of 3 blue transparent    | 630 160 |
| Click-In Display with 9 pcs. | 635 171 |

### Practice box for patient education

- Content:
- Pic-Brush IP probe
  - Pic-Brush holder
  - Pic-Brush brushes (7 different diameters, 6 brushes of each)
  - I-Prox P holder
  - I-Prox P brushes (4 brushes)
  - Patient recommendation pad with 25 sheets

| Article description | REF     |
|---------------------|---------|
| miradent Demo Box   | 635 026 |

## I-Prox P®

### Switch-function

a push connection allows two different attachments angles for various possible applications



## I-Prox® Care Set



## miradent® Demo Box



## Mira-2-Ton® Solution



### Plaque test

- Chewable tablet or solution
- Older plaque is revealed in blue, newer plaque in pink
- Proven in the dental practice for years
- Patient-friendly, motivating
- Erythrosine- and gluten-free
- Discolourations can be removed by brushing teeth
- Easily to halve – one tablet sufficient for 2 applications

| Article description          | Content      | REF     |
|------------------------------|--------------|---------|
| Mira-2-Ton solution          | 60 ml        | 605 655 |
| Mira-2-Ton solution          | 10 ml        | 605 659 |
| Mira-2-Ton solution, Display | 10+2 x 10 ml | 605 660 |

## Mira-2-Ton® Tablets



| Article description               | Content/Colour   | REF     |
|-----------------------------------|------------------|---------|
| Mira-2-Ton tablets                | 6 pcs.           | 631 027 |
| Mira-2-Ton tablets                | 50 pcs. (5 x 10) | 605 765 |
| Mira-2-Ton tablets                | 250 pcs. (lose)  | 605 768 |
| Mira-2-Ton tablets, Display       | 16 x 6 pcs.      | 635 184 |
| Mouth mirror (ø 23 mm) separately | blue transp.     | 630 065 |
| Mouth mirror (ø 23 mm) separately | pink transp.     | 630 066 |

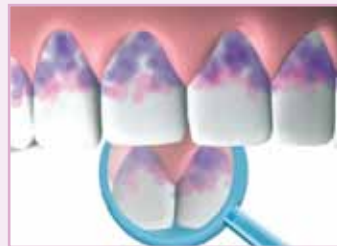

## miradent SOS Dentobox®

### Tooth rescue box after tooth accidents

- Special nutrient solution prolongs the chances to replant avulsed teeth and fragments for up to 48 hours
- Cells of the desmodontium remain intact until replantation
- Safe and verifiably best storage for preservation of one's tooth



| Article description           | Content | REF     |
|-------------------------------|---------|---------|
| miradent SOS Dentobox         |         | 631 040 |
| miradent SOS Dentobox Display | 6 pcs.  | 635 115 |

### Oral care spray for immediate fresh breath

- Eliminates mouth odour (halitosis)
- Dental care properties due to added xylitol (10%)
- Alcohol-free

| Article description     | Content         | REF     |
|-------------------------|-----------------|---------|
| halitosis spray         | 15 ml spray can | 630 168 |
| halitosis spray Display | 12 spray cans   | AK-1203 |

## halitosis spray



### Mouth rinsing solution with chx 0.2 %

- Preoperative use due to chlorhexidine gluconate (0.2 %)
- Remineralizing due to fluoride (250 ppm)
- Astringent due to hamamelis
- Anti-cariogenous due to xylitol
- Alcohol-free

| Article description | Content | REF     |
|---------------------|---------|---------|
| paroguard chx 0.2%  | 200 ml  | 630 087 |

## paroguard® chx



**Dosing cap**  
For easy-to-measure doses of the mouth rinsing solution

### Size with advantage 5 liters

- Optionally available with dosing pump (1 push = 10 ml)

| Article description               | Content  | REF     |
|-----------------------------------|----------|---------|
| paroguard chx 0.2% (without pump) | 5,000 ml | 630 127 |
| Pump separately                   |          | 630 138 |

## paroguard® chx 5000 ml



### Mouth rinsing solution with chx 0.06 %

- For daily use, incl. dosing cap
- Remineralizing due to fluoride (250 ppm)
- Astringent due to hamamelis
- Anti-cariogenous by xylitol
- Alcohol-free
- Support of daily mouth care due to chlorhexidine gluconate (0.06 %)

| Article description | Content | REF     |
|---------------------|---------|---------|
| mirafluor chx 0.06% | 100 ml  | 630 085 |
| mirafluor chx 0.06% | 500 ml  | 630 086 |

## mirafluor® chx



## Infant-O-Brush®



### Learner's toothbrush integrated in a teething ring

- Teaches regular dental care in a playful way
- Teething ring with extra soft bristle field
- Nubs enhance dentition
- Oval shape eliminates risk of swallowing and injury
- For infants from 3 months of age

| Article description | REF     |
|---------------------|---------|
| Red                 | 631 026 |
| Yellow              | 605 617 |

## miradent® Hourglass



### Child-appropriate hourglass as timer for tooth brushing

- Ideal for observing the recommended minimum brushing time
- Running time: 2 minutes
- Attachable to any smooth surfaces due to suction cup



| Article description | REF     |
|---------------------|---------|
| miradent Hourglass  | 630 068 |

## Dento Box® I



### Solid transport and storage box

- For prosthesis, orthodontic works, etc.
- Impact-proof, safe snap lock and small ventilation holes
- With trendy hang cord

| Article description | Content | REF     |
|---------------------|---------|---------|
| Dento Box I, white  | 1 pcs.  | 630 162 |
| Dento Box I, blue   | 1 pcs.  | 630 161 |
| Dento Box I, pink   | 1 pcs.  | 630 163 |



### Tooth rinsing solution for plaque control

- Existing plaque is revealed in blue
- Pleasant "bubble gum" flavour
- Ready-to-use, motivating, child-friendly
- Colouring can be easily removed by brushing teeth
- Application: 1–2 x per day 10 ml, rinse for approx. 30 sec. prior to toothbrushing
- Erythrosine-free, alcohol-free
- Incl. dosing cap

| Article description  | Content | REF     |
|----------------------|---------|---------|
| Plaque Agent         | 500 ml  | 631 096 |
| Plaque Agent Display | 5 pcs.  | 635 176 |

### Hygienic toothbrush holder

- Easy snapping in place and removing of toothbrush
- Patented snap lock
- Two suction cups for attaching to all even surfaces
- Ventilation slots ensure an ideal air exchange
- Fitting for any off-the-shelf toothbrush

| Article description | REF     |
|---------------------|---------|
| Funny cow           | 630 099 |
| Funny elephant      | 630 100 |
| Funny zebra         | 630 101 |
| Funny lion          | 630 102 |
| Funny pig           | 630 103 |
| Funny dog           | 630 104 |

### Children's Toothbrush

- Small head with oval bristle field
- Plane tuft field with soft rounded nylon bristles
- "Upper body" is hinged and protects the bristle field
- Air circulation by opening in the protective cap
- Brush handle simultaneously serves as practical stand
- For children from the age of four

| Article description | REF     |
|---------------------|---------|
| Duck                | 630 046 |
| Parrot              | 630 047 |
| Bear                | 630 048 |
| Dog                 | 630 049 |
| Bull                | 630 051 |
| 5 pcs. assorted     | 605 820 |

## Plaque Agent®



## Funny Animals



Suction cups  
attachable to any  
smooth surfaces

## Kid's Brush



## Tong-Clin® Gel



### Tongue cleaning gel with a gentle and nurturing cleaning effect

- Removes tongue coatings gently
- Nurtures with camomile, sage and calendula
- Long-lasting feeling of freshness
- Alcohol-free

| Article description | Content                      | REF     |
|---------------------|------------------------------|---------|
| Tong-Clin Gel       | 50 ml                        | 630 059 |
| Tong-Clin Set       | 1 tongue cleaner + 50 ml Gel | 631 060 |

## Tong-Clin De Luxe®



### Tongue cleaner

- Dual function in one instrument:
  - Bristle field with short, rounded bristles lifts off tongue coatings
  - Tongue scraper removes the loosened coatings subsequently
- Angled, flat arched top reduces gag reflex
- Handy finger-grip handle with protective cap

| Article description        | Content | REF     |
|----------------------------|---------|---------|
| Blue transparent           |         | 631 029 |
| Pink transparent           |         | 631 030 |
| Blue                       |         | 605 778 |
| Click-In Display, assorted | 9 pcs.  | 635 170 |

## Protho Brush® De Luxe



### Prosthesis brush

- With two brush heads: large brush field for cleansing of outer prosthesis surfaces and smaller brush field for the hard-to-reach inner sides
- Ergonomically shaped finger form-grip handle

| Article description        | Content | REF     |
|----------------------------|---------|---------|
| Blue transparent           |         | 631 024 |
| Pink transparent           |         | 631 025 |
| Dark blue                  |         | 605 413 |
| Click-In Display, assorted | 9 pcs.  | 635 169 |

## Protho Box®



### Waterproof, lockable prosthesis box

- For storage and cleaning of prosthesis
- Waterproof due to special locking
- Holds 2 prostheses and approx. 80 ml of liquid
- Also suitable for storage of removable braces
- Box contains double-sided cleaning brush, white bristles for basic surfaces, black bristles for prostheses indentations
- Brush compartment also for cleaning tablets
- With mirror in the lid

| Article description | REF     |
|---------------------|---------|
| Box incl. brush     | 605 900 |
| Brush separately    | 605 901 |

### Oral health rapid test for paradontitis early detection and risk assumption

- Preventive: Indicates acute risk of paradontitis before conventional diagnostics
- Painless: gentle and fearless diagnosis after only 10 minutes
- Delegable: screening, monitoring and follow-up by dentals assistance
- Successful: for sensitisation, motivation and gaining of patients
- Interdisciplinary: to avoid secondary damage for patience with cardio-vascular symptoms, diabetics, rheumatic patients, women with desire to have children or heavy smokers
- Parodontal atrophy is detected by measuring the enzyme aMMP-8 (active matrix-metalloproteases)

| Article description | Content            | REF     |
|---------------------|--------------------|---------|
| PerioMarker         | 2 separately tests | 605 852 |

### ImplantMarker-Rapid test of implant health for early detection of periodontal bone loss- and tissue atrophy processes

- Prognostic: Regular implant screening detects PI risks long before conventional diagnostics
- Preventive: Helps avoiding periodontal bone loss by early begin of therapy
- Painless: Atraumatic sample taking at the implant. Diagnosis after only 10 minutes
- Successful: For sensitisation, motivation and patient retention
- Delegable: Economic optimisation of recalls, screening by dentist or dental assistance
- Early detection of concealed tissue loss by detecting the active matrix collagenase (aMMP-8) at the dental implant

| Article description | Content            | REF     |
|---------------------|--------------------|---------|
| ImplantMarker       | 4 separately tests | 152 052 |

### Disposable toothbrush with xylitol

- Bristles are impregnated with xylitol toothpaste
- Fresh flavour
- Short head design (2.5 cm)
- Hygienically and separately packed
- Ideal when traveling, in between meals and as toothbrush for guests
- Xylitol has an anti-cariogenous effect, decreases plaque- and acid-forming bacteria



After meals



When travelling



In the office



Prior the date

| Article description   | Content | REF     |
|-----------------------|---------|---------|
| Happy Morning Xylitol | 50 pcs. | 605 496 |

## PerioMarker®



## ImplantMarker

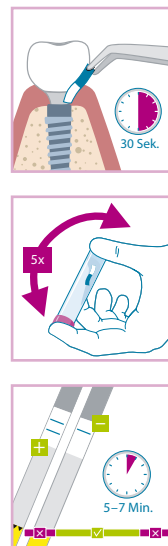

## Happy Morning® Xylitol



## Putzi-Pets



### Hand puppets with denture

- The ideal aid to motivate children
- For explanation of appropriate dental care
- For persuading children of the necessary treatment measures
- Special effect: With the small water bottle, the puppets turn into water pistols
- Cute and useful
- In four animal characters

| Article description | REF     |
|---------------------|---------|
| Putzi Croc          | 707 045 |
| Putzi Dino          | 707 046 |
| Putzi Cow           | 707 047 |
| Putzi Horse         | 707 048 |

## Miratoi® No. 1



### Mixed Assortment

- Cars, boats, combs, etc.



| Article description     | Content  | REF     |
|-------------------------|----------|---------|
| Miratoi No. 1, assorted | 150 pcs. | 605 690 |

## Miratoi® No. 3



### Farm Set

- Different farm animals



| Article description     | Content  | REF     |
|-------------------------|----------|---------|
| Miratoi No. 3, assorted | 100 pcs. | 605 692 |

## Miratoi® No. 4



### Zoo Set

- Different zoo animals

| Article description     | Content  | REF     |
|-------------------------|----------|---------|
| Miratoi No. 4, assorted | 100 pcs. | 605 693 |

**Gifts for the young patients.**

Various toy assortments made of non-toxic plastics or non-toxic metals.

A contribution to successful practice-marketing not to be underestimated!

### Finger rings

- Lovely finger rings in various sizes



| Article description     | Content  | REF     |
|-------------------------|----------|---------|
| Miratoi No. 6, assorted | 100 pcs. | 605 694 |

### Watches

- Puzzle in the shape of watches in various colours



| Article description     | Content | REF     |
|-------------------------|---------|---------|
| Miratoi No. 7, assorted | 84 pcs. | 605 695 |

### Bouncy balls

- Funny bouncy balls in different colours
- ø 2.5 cm



| Article description     | Content  | REF     |
|-------------------------|----------|---------|
| Miratoi No. 8, assorted | 100 pcs. | 605 696 |

### Miniature cars and boats

- Miniature cars and boats in different colours

| Article description      | Content  | REF     |
|--------------------------|----------|---------|
| Miratoi No. 10, assorted | 100 pcs. | 605 698 |

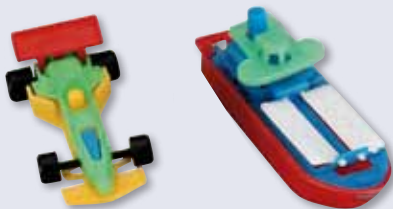

### Miratoi® No. 6



### Miratoi® No. 7



### Miratoi® No. 8



### Miratoi® No. 10



## Miratoi® No. 11 and No. 12



### Medal set

- Special award as motivation for brave young patients
- Stamped medal with ribbon
- Miratoi No. 11 made of nickel-free golden metal
- Miratoi No. 12 made of plastic

#### Certificates in different languages available on request!

D - GB - F - E - IT - NL - HR - SRB - MK - P



Metal



Plastic

#### Package with 50 pcs. and 50 certificates

| Article description     | Content | REF     |
|-------------------------|---------|---------|
| Miratoi No. 11, metal   | 50 pcs. | 605 703 |
| Miratoi No. 12, plastic | 50 pcs. | 605 706 |

## Miratoi® No. 13

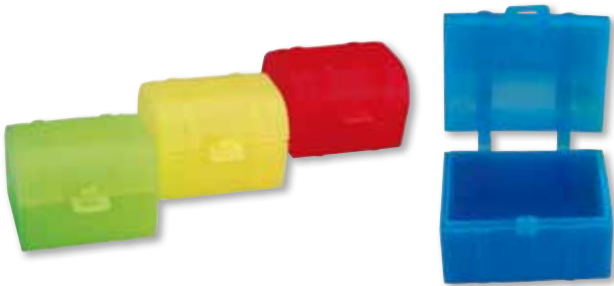

### Treasure chests

- Ideal for the safekeeping of deciduous teeth



| Article description      | Content  | REF     |
|--------------------------|----------|---------|
| Miratoi No. 13, assorted | 100 pcs. | 605 699 |

## Miratoi® No. 15



### Mini Ponies

- For combing and cuddling
- In five different colours

| Article description | Content | REF     |
|---------------------|---------|---------|
| Miratoi No. 15      | 50 pcs. | 605 701 |

## Miratoi® No. 17



### Fingerboards

- Ultimate fingerboards in five cool designs



| Article description | Content | REF     |
|---------------------|---------|---------|
| Miratoi No. 17      | 50 pcs. | 605 707 |

## Relaxation headphones for patients

- Relaxation and comfort for the patient
- Volume Management Technology – manages output volume up to 82 dBA
- Reduces noises (reduction rating 25 dB)
- For playing MP3, mobile phones or other audio devices
- Includes 10 hygienic “Comfort Pads” (ear cushions)

**Comfort Dream Intro Kit includes:** Stereo headphones, 3.5 mm replacement audio cable and 10 “Comfort Pads” (ear cushions)

| Article description               | Content  | REF     |
|-----------------------------------|----------|---------|
| Comfort Dreams Intro Kit          | 1 pcs.   | 355 555 |
| Comfort Dreams, cool pads         | 100 pcs. | 355 556 |
| Comfort Dreams, replacement cable | 1 pcs.   | 355 557 |

## Effective relaxation aid

- By squeezing the tooth, the patient gets pleasantly distracted
- Ideal for stress relaxation or as a gift
- Dimensions: 64 x 54 x 38.5 mm, weight: 42 g
- Material: polyurethane

| Article description | REF     |
|---------------------|---------|
| Anti Stress Tooth   | 707 002 |

## Cream for hand care

- Free of mineral oils and silicones
- Free of artificial colours
- Free of animal-derived ingredients
- Free of synthetic perfumes

### ALOE VERA for normal and sensitive skin

- Easily absorbed by the skin

### OLIVE-BUTTER for demanding and dry skin

- Pleasant for people suffering from skin diseases, such as neurodermatitis
- Easily absorbed by the skin

### SHEA-BUTTER for demanding and dry skin

- Rich and easily absorbed by the skin

### Value pack– low price

| Article description | Content | REF     |
|---------------------|---------|---------|
| Aloe Vera cream     | 500 ml  | 660 302 |
| Olive Butter cream  | 500 ml  | 660 300 |
| Shea Butter cream   | 500 ml  | 660 301 |

## Comfort Dreams



## Anti Stress Tooth



## Plantana®



# Laser in Daily Practice Use

## The Key to Therapeutic and Economic Success

Authors: Dr. Frank Liebaug (Prof. Hangzhou University, China), Dr. Ning Wu

**Laser dentistry went through a rapid development within the last years. Today, the use of laser devices enhances the whole dental treatment range valuably and supports conventional as well as conservative therapies. So the practitioner achieves more safety and a better clinical result can be obtained for the patient in a gentle way. In the following, the authors show different alternatives based on clinical case studies.**

Especially for the colleagues with their own practice it is important to study the possibilities, but also the limitations of modern laser dentistry and to get an idea about the possible introduction in their practice.

### Practical indication for lasers in dentistry

Today, application fields of laser devices in oral therapy are to be found in diagnostics, caries and hard tissue removal, periodontology, antimicrobial, photodynamic therapy of mucosa diseases, endodontics, implantology and preparation of suprastructures, periimplantitis therapy (fig. 2), high-quality prosthetics, laser-supported pediatric dentistry, prophylaxis, bleaching and – last but not least – in esthetic dentistry.



Fig. 1: Antimicrobial, photodynamic therapy in marginal periodontitis

### Wavelengths determine indication of use

However, there is not just one device for all applications and indications, in fact the indication is determined by the respective wavelength of the

laser. Caries and hard tissue removal are treated with the Er:YAG device. As these devices are high-end developments, they are connected with high investment costs for the dental practice. If appropriately used by the dentist and integrated into the daily treatment concept, the use of such devices is reasonable midterm, therapeutically as well as economically.

Within the last years, various dental laser systems have gained importance in the therapy of periodontitis. In principle, the use of laser can only be seen as completion of the conventional, systematic therapy even though the field of non-surgical periodontal therapies could have been expanded by laser application meanwhile. Before using laser devices, the patient must be prepared in terms of a completed initial therapy. Due to the latest developments in the field of laser technology, it seems to be conceivable that even the removal of concretions can be done by means of a laser.

### Usage of laser creates an antibacterial environment and supports healing

Primarily, however, the dentist takes advantage of the bactericidal effect of a certain wavelength. Numerous studies and publications in various fields of dentistry have proved that laser shows an excellent antibacterial effect in the infrared area and that it is able to deactivate bacterial toxins. This effect starts developing at an



Fig. 2: Laser for periimplantitis therapy, 17 years post implantationem and dental bar provision

output power clearly underneath the limit for a thermal damage of soft and hard tissue. Thin and flexible light conductor systems bring the laser radiation to nearly any desired place and can be well used even in the bifurcation area of molars. So it seems to be obvious to profit from these advantages in connection with a systematic periodontal therapy. If the output power is increased, also pocket epitheliums in terms of a closed curettage can be removed with an Nd:YAG or diode laser. Therefore, pocket decontamination with the laser is very effective, even in case of an acute local periodontitis.



For short video demonstration of LaserHF please scan QR code.

<http://www.youtube.com/watch?v=q9shWCT1Udc>





Fig. 3: Pocket decontamination at telescopic tooth with a laser



Fig. 4: Laser decontamination of root canals at a molar under Rubberdam



Fig. 5: Laser incision at acute, submucous abscess in primary dentition



Fig. 6: Laser application for desensitization of hypersensitive tooth surfaces

Fig. 7: The LaserHF device used in our practice and for our examples

### Advantages of Laser-Supported PA Therapy

Most dentists as well as patients will quickly realize the advantages especially in the fields of periodontology and laser-supported endodontics. For the field of laser-supported\* periodontal therapy this means:

- no bleeding after treatment, even in patients suffering from a blood-clotting disorder or taking anti-coagulants\*
- significantly less anesthesia demand
- agreeable and easier treatment
- better healing process without complications
- considerably less postoperative pain
- drinking and eating possible after subsiding of anesthesia
- less postoperative hypersensitivities of tooth necks by sealing of dentin tubuli
- germ reduction in periodontal pockets (fig. 3)

### Advantages of Laser-Supported Endodontic Treatment

The success rate in endodontic therapy can be significantly increased by a consequent use of the laser device, too, thus avoiding surgical interventions to the point of necessary tooth extraction in case of clinical failures (fig 4).

A major advantage is the 99 % germ reduction\* in the root canal immediately after exposure to laser light resulting in:

- possibly no medicamentous insert
- time saving, often whole treatment in just one appointment
- sealing of the apical dentin tubuli
- avoiding of apicectomy

### Clinical Examples

The following case studies show just a small selection of treatment possibilities, without claim to be complete, to encourage interested colleagues to integrate innovative methods into the daily practice in the interest of their patients. It is not to be underestimated that especially children and anxious, sensitive patients are very open to this treatment method. One example should be the incision of an acute submucous abscess in the primary dentition (fig. 5). But also the relatively many patients with herpes labialis or sore stomatitis aphtosa respond positively to the oral laser therapy. Hypersensitive tooth surfaces can be treated effectively with the non-contact procedure (fig. 6).

The newcomer might have difficulties to find the appropriate device on the current dental market. Aside from devices with just one laser of a certain wavelength, the combination unit LaserHF, which we use in our practice, has been available for more than a year now (fig. 7). Apart from a diode laser with a wavelength of 975 nm, this device includes a low-level-laser with 660 nm and an additional high frequency surgery unit for cutting and coagulation.

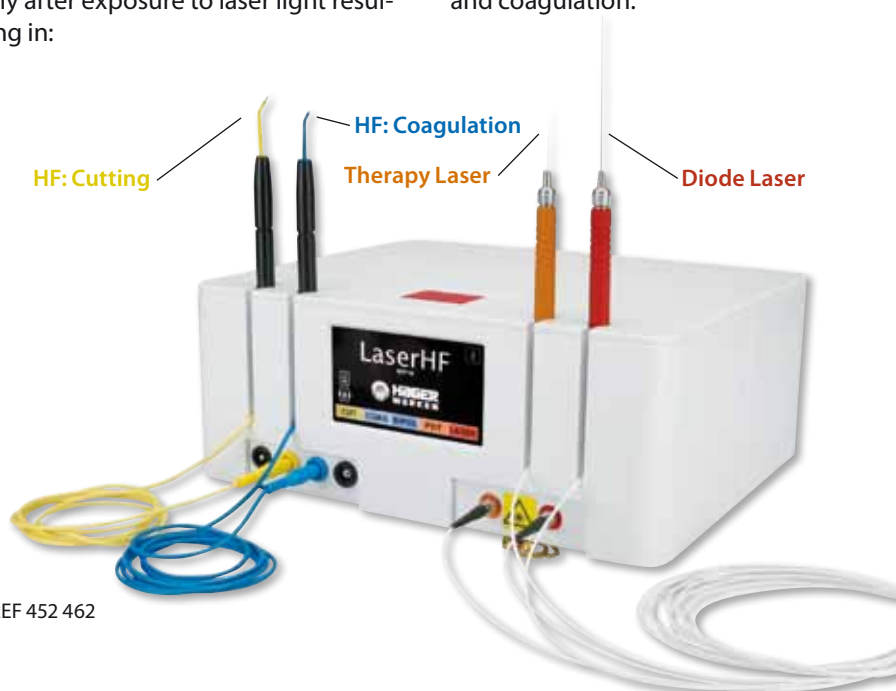

REF 452 462

\*Source: Prof. Dr. Liebaug (Germany)

*Dental practice:* \_\_\_\_\_

*Contact person:* \_\_\_\_\_

*Phone:* \_\_\_\_\_

*Fax:* \_\_\_\_\_ *E-Mail:* \_\_\_\_\_

*Address:* \_\_\_\_\_ *Country:* \_\_\_\_\_

*Please send me:*

**miradent**

- Product Information (booklet) WE-9006
- miradent Display-Flyer

**Hager & Werken**

- Lab Catalog WE-9911
- LaserHF® Info-Flyer 2013012404
- Rubberdam booklet 160001
- N2 Endo (Sargenti Method)
- Infection Prophylaxis (Miramatic & More)

*Please send me information regarding the following products:* \_\_\_\_\_

\_\_\_\_\_

\_\_\_\_\_

\_\_\_\_\_

Hager & Werken GmbH & Co. KG  
 Ackerstraße 1 · 47269 Duisburg, Germany  
 Tel. +49 (203) 99269-0  
 Fax +49 (203) 299283  
 E-Mail info@hagerwerken.de  
 Internet www.hagerwerken.de







**Your partner  
for dental specialities,  
ideas and service.**



Häger & Werken GmbH & Co. KG  
Ackerstraße 1, 47269 Duisburg, Germany  
Tel. +49 (203) 99269-0  
Fax +49 (203) 299283  
E-Mail [info@hagerwerken.de](mailto:info@hagerwerken.de)  
Internet [www.hagerwerken.de](http://www.hagerwerken.de)

Please see our general terms and conditions  
at [www.hagerwerken.de](http://www.hagerwerken.de)